

Price list USA

Bulo

List prices in USD

1st June 2024

CONTENT

SEATING



B7
p.5

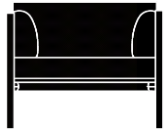

Dan Lounge
p.13



Easy Rider
p.209



Monica
p.23



Pub & Club
p.29



Skater
p.33



SL58 / SLL18
p.35 / 42



Tab Mesh
p.53



Tab Chair
p.55



Tab Lounge
p.57



VVD Chair
p.59



VVD Bistro Chair
p.71

FABRIC LIBRARY - p.215

STORAGE AND ACCESSORIES



Dan rack
p.93



Electrification
p.179



Modular Storage
p.189



Montado Cork
p.211

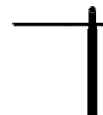

Lucca
p.17



Mr. Walter
p.201



Overdose
p.210



Screens
p.169

CONTENT

DESK SYSTEMS

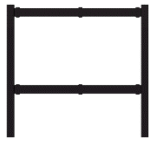

Dan
p.87



grID
p.99



H2O
p.109



Kei
p.123



Normal
p.131



SB55
p.137



Senses
p.147



VVD Desk
p.165

TABLES



H2O
p.109



Kei
p.123



Overdose
p.210



SB55
p.137



Senses
p.147

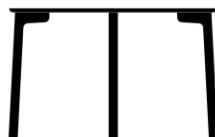

VVD Bistro Table
p.81

B7 sofa

by B-Brand



B7 sofa

by B-Brand

B7 is a modular seating element with an atypical square footprint constructed from a pure geometric stacking. Stripped of any ornamentation, this furniture invites to sit, work, lay down and hang in different settings, both business and residential.

B7 is conceived as a stacking of volumes. The seating elements consist out of a round base made of black lacquered multiply with an upholstered seat. The seat and the back rest are connected through a low, recessed, black lacquered multiply volume that creates a shadow gap.

The upholstered back rest lends itself as a seat or work surface whether or not completed with a removable tray.

Connecting sofa elements and/or extension elements

The sofa elements can be used freestanding or can be attached to an other sofa element, in which case the separate connecting kit (see 4.3.) is required.

The rectangular 47.24" x 17.72" extension pouf can not be used freestanding. It has to be connected to another element.

All extension elements include the connectors to connect them to a sofa element.

Connecting 3 or more powered sofa elements 47.24" x 47.24" on request.

Foam & upholstery

The foam of the seating elements is combustion modified polyurethane, complying to BS 5852: Part 2:1982 (Schedule 1: Part 1) and Crib 5.

The seating elements are upholstered with fabric Encircle by Kvadrat. All colorways are possible.

The cushion is upholstered with fabric Vidar4 by Kvadrat in the color black, to complement the black base and the shadow gap between the back rest and the seat.

Base

The sofa elements have a round base, diam. 47.24" on adjustable feet

The rectangular and square poufs have a round base, diam. 13.78", on adjustable feet

The bases are made out of black lacquered multiply.

Electrification

The sofa elements 47.24" x 47.24" can be equipped with a power outlet in the seat and/or a wireless charger in the back rest

The round power outlet diam. 3.15" has 1 power and 1 USB-C and is placed in the front and/or in the back of the seat.

The unit in the top of the back rest is equipped with a wireless charger and 2 x USB-C.











Each freestanding sofa element with electrification is powered by only 1 mains lead 118" long (included).

Each combination of 2 powered sofa elements is powered by only 1 mains lead (included).

Exemption: a combination of 2 sofa elements each with 1 round power unit, is powered by 2 mains leads 118" long (included)

B7 sofa

1. Sofa element with back rest

	Code	List price
 <p>w. 47.24" x d. 47.24" x h. 25.59" Seat height 17" Can be used freestanding or can be attached to another sofa element or extension pouf To attach to another sofa element, add the assembly kit, see 4.3</p>		
1.1 Without electrification		
	B71000000 **	6.350
1.2. Power & usb-c in the seat front on the left		
	B71FL00 * **	6.805
1.3. Power & usb-c in the seat front on the right		
	B71FR00 * **	6.805
1.4. Wireless charger & 2 x usb-c in the top of the back rest on the right		
	B7100TR * **	6.780
1.5. Wireless charger & 2 x usb-c in the top of the back rest on the left		
	B7100TL * **	6.780
1.6. Power & usb-c in the seat front on the left and wireless charger & 2 x usb-c in the top of the back rest on the right		
	B71FLTR * **	7.235
1.7. Power & usb-c in the seat front on the right and wireless charger & 2 x usb-c in the top of the back rest on the right		
	B71FRTR * **	7.235
1.8. Power & usb-c in the seat front on the left and wireless charger & 2 x usb-c in the top of the back rest on the left		
	B71FLTL * **	7.235
1.9. Power & usb-c in the seat front on the right and wireless charger & 2 x usb-c in the top of the back rest on the left		
	B71FRTL * **	7.235

FINISHES & CODES

* Electrification

BE Belgium/France - type E
DU The Netherlands/Germany/Schuko - Type F
UK United Kingdom - Type G
US United States - Type B







** Fabric

EN... Encircle by Kvadrat

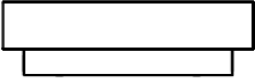
... = add fabric color code

B7 sofa

2. Sofa element without back rest

	Code	List price
 <p>w. 47.24" x d. 47.24" x h. 17" Can be used freestanding or can be attached to another sofa element or extension pouf To attach to another sofa element, add the assembly kit, see 4.3</p>		
2.1 Without electrification		
	B72000000 **	5.075
2.2. Power & usb-c in the seat front on the left		
	B72FL00 * **	5.525
2.3. Power & usb-c in the seat front on the right		
	B72FR00 * **	5.525
2.4. Power & usb-c in the seat front on the left and in the seat back on the right		
	B72FLBR * **	5.980
2.5. Power & usb-c in the seat front on the right and in the seat back on the left		
	B72FRBL * **	5.980

FINISHES & CODES

* Electrification

- BE Belgium/France - type E
- DU The Netherlands/Germany/Schuko - Type F
- UK United Kingdom - Type G
- US United States - Type B



** Fabric

EN... Encircle by Kvadrat

... = add fabric color code

B7 sofa

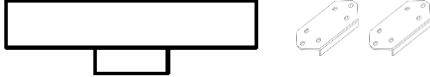
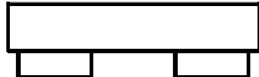
3. Poufs

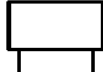
	Code	List price
<p>3.1. Rectangular extension pouf w. 47.24" x d. 17.72" x h. 17" On 1 round base, with adjustabl feet Can not be used freestanding Includes assembly kit for attachment to a sofa element</p> 	B73000000 **	2.920
<p>3.2. Rectangular freestanding pouf / coffee table w. 47.24" x d. 17.72" x h. 17" On 2 round bases, with adjustable feet Can not be connected to another element</p> 	B74000000 **	3.795
<p>3.3. Square extension pouf w. 17.72" x d. 17.72" x h. 17" On 1 round base, with adjustable feet Includes assembly kit for attachment to a rectangular extension pouf Can not be connected to a sofa element</p> 	B75000000 **	2.230
<p>3.4. Square freestanding pouf w. 17.72" x d. 17.72" x h. 17" On 1 round base, with adjustable feet</p> 	B76000000 **	2.095

FINISHES & CODES

* Electrification

BE Belgium/France
DU The Netherlands/Germany/Schuko
UK United Kingdom
US United States



** Fabric

EN... Encircle by Kvadrat

... = add fabric color code

B7 sofa

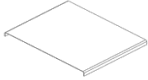
4. Accessories

	Code	List price
<p>4.1. Cushion w. 23.62" x d. 5.9" x h. 12.6" Upholstery in fabric Vidar4 by Kvadrat, color 1880 black</p> 	B7CUVI1880	525
<p>4.2. Tray w. 17.83" x d. 16.54" In black powdercoated metal Can be placed on a rectangular pouf or on the backrest of a sofa element</p> 	B7TR04	295
<p>4.3. Connecting kit to connect 2 sofa elements 47.24" x 47.24" to each other. Consists out of 2 connecting plates with screws</p> 	B7CS2	85

B7 sofa

5. Upholstery

Encircle - colours



112



652



132



662



172



722



182

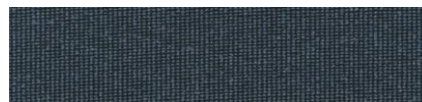

752



222



762



252



862

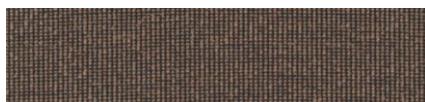

352



922



452



982



572

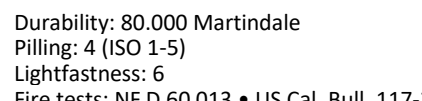

982

Durability: 80.000 Martindale

Pilling: 4 (ISO 1-5)

Lightfastness: 6

Fire tests: NF D 60 013 • US Cal. Bull. 117-2013 • NFPA 701

• BS 5852 Crib 5 • EN 1021-1/2 • AS/NZS 3837 class 1 •

IMO FTP Code 2010 Part 8 • DIN 4102 B1 • NF P 92 507 M1

• UNI 9175 1IM • BS 5867 part 2 type B • SN 198 898 5.2 •

EN 13501-1, B-s1, d0 • ÖNORM B1/Q1 • CAN ULC S102 •

CAN ULC S109 • IMO FTP Code 2010 Part 5 • GB 8624 B1

• ASTM E84 Class A Unadhered

Vidar4



1880

DAN Lounge

by BuloDesign



DAN Lounge

Sofa

Seat height 18.50"

List prices

Code	Fabric				leather
	Cat. 2	Cat. 3	Cat. 4	Cat. 5	

DAN is in essence a modular collection. The construction is based on traditional Japanese joinery.

It exists out of solid ash wood ladders and beams, and metal connecting parts.

The name DAN, meaning 'level' in Japanese martial arts, refers to the ladder system.

DAN is an environmentally friendly collection. The structure is made out of CO2 neutral, FSC certified solid ash wood from European origin.

The connectors are made out of recycled aluminium which reduces the CO2 emission with 80% compared to new aluminium.

Seat depth: 20.47"

1. Armchair

w 34.65" x d 30.83" x h 31.10"

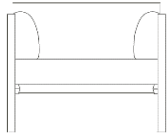

DANSO1ZLR *	3.925	4.265	4.610	4.950	6.730
--------------------	--------------	-------	-------	-------	-------

2. 2-seater sofa

w 67.48" x d 30.83" x h 31.10"

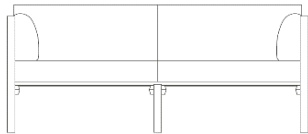

DANSO2ZLR *	5.795	6.305	6.815	7.335	9.970
--------------------	-------	-------	-------	-------	-------

3. One arm sofa

w 67.48" x d 30.83" x h 31.10"



DANSO2LLR *	5.290	5.805	6.315	6.825	9.470
--------------------	-------	-------	-------	-------	-------



DANSO2RLR *	5.290	5.805	6.315	6.825	9.470
--------------------	-------	-------	-------	-------	-------

* FINISHES & CODES

1) Structure

AB solid ash, black lacquered
AN solid ash, natural
 AW solid ash, walnut color stained

2) Connectors

B black
R red

3) Upholstery

Fabric cat. 2	Fabric cat. 3	Fabric cat. 4	Fabric cat. 5
CE... César	BL... Blazer	AR... Arco	HA... Hallingdal 65
CO... Comeback	LALO... Lobo	CL... Cleo	CT... Steelcut 3
MLF... Main Line Flax	ME... Meld	CR... Credo	TR... Steelcut Trio 3
RN... Renew	MR... Merit	EN... Encircle	VI... Vidar 4
	RW... Re-wool	SH... Shake	
		TP... Topia	Leather
			LE1000 Black
			LE1171 Warm grey
			LE1614 Pearl
			LE2354 Sienna
			LE2691 Dark brown
			LE8246 Mustard

... = add fabric color code

Code example: DANSO1ZLRANRCO45 = 3.925

DAN Lounge

Sofa

Seat height 18.50"

List prices

Code	Fabric				leather
	Cat. 2	Cat. 3	Cat. 4	Cat. 5	

4. Cove
w 67.48" x d 30.83" x h 50"

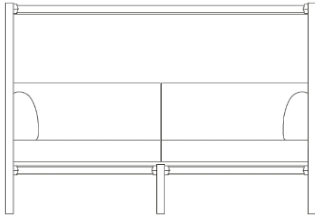

DANSO2ZHR *

6.015 6.600 7.200 7.800 10.840

5. Box
w 92.5" x d 66.5" x h 50"
Opening w 31.10"

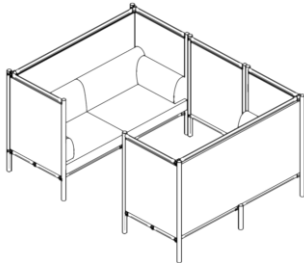

DANSOBOHR *

13.935 15.210 16.510 17.800 24.745

* FINISHES & CODES

1) Structure

AB solid ash, black lacquered
AN solid ash, natural
 AW solid ash, walnut color stained

2) Connectors

B black
R red

3) Upholstery

Fabric cat. 2

CE... César
 CO... Comeback
MLF... Main Line Flax
 RN... Renew

Fabric cat. 3

BL... Blazer
 LALO... Lobo
 ME... Meld
 MR... Merit
 RW... Re-wool

Fabric cat. 4

AR... Arco
 CL... Cleo
 CR... Credo
 EN... Encircle
 SH... Shake
 TP... Topia

Fabric cat. 5

HA... Hallingdal 65
 CT... Steelcut 3
 TR... Steelcut Trio 3
 VI... Vidar 4

Leather

LE1000 Black
 LE1171 Warm grey
 LE1614 Pearl
 LE2354 Sienna
 LE2691 Dark brown
 LE8246 Mustard

... = add fabric color code

Code example: DANSO2ZHRANRMLF36 = 6.015

DAN Lounge

Colors and materials

LADDERS AND SUPPORTING BEAMS



Solid ash wood
black lacquered



Solid ash wood
natural varnished

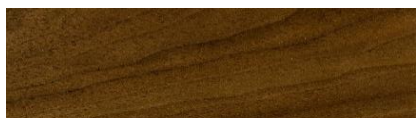

Solid ash wood
walnut color stained

CONNECTORS



Metal, powder
coated coral-red
RAL3016 matte



Metal,
black anodized

FABRICS

Lucca

by Bulo Design in collab with Gensler



Lucca

by Bulo Design in collab with Gensler

Gensler is a global architecture, design and planning firm with 50 locations and more than 6000 professionals networking across the world.

Founded in 1965, the firm serves more than 3500 active clients in virtually every industry. Gensler supports clients at every stage of the design cycle. In 2019 Bulo and Gensler teamed up to design this lounge collection.

Monica and Lucca are quintessential Bulo. Both timeless and contemporary, they feel at home in different interiors. Classical woodworking and upholstery is combined with state-of-the-art production techniques.

Lucca is a convenient side table that also explores duality. With a simple click- and pull system the height of this laptop table can be adjusted to either 18.50" or 26.38". Also available with a fixed height of 22.44" and for larger laptops with a larger top and foot on a fixed height of 26.38".

Lucca shares many of the same characteristics of his big sister Monica. A combination of natural products and traditional craftsmanship with clever solutions for modern work environments, makes him a versatile and functional addition to your home and office.

Technical information:

Handle in solid wood: ash, black lacquered ash or walnut.

Oval table top in mdf with knife edge. Possible finishes: powdercoated, Fenix hpl or veneer, 0.63" thick of which 0.4" straight edge.

Round powdercoated metal column leg diam. 1.57"

There are 3 Lucca models:

- Table top 15.75" x 18.70", fixed height 22.44". Oval foot plate 11.02" x 13".
- Table top 15.75" x 18.70", height adjustable in 2 positions: 18.50" and 26.38". Oval foot plate 11.02" x 13".
- Table top 15.75" x 20.87", fixed height 26.38". Oval foot plate 11.02" x 14.96".

All mentioned heights are the table top heights and exclude the height of the handle. The handle is fixed and is 3.27" high.

We point out that wood is a natural material.

In products where veneer or solid wood is applied it is therefore possible that there is variation in color and grain within one order with multiple of these products in the same veneer or solid wood, or even within one product. Our wood samples are made from another tree than the final product. This means that the veneer or solid wood in the final products can deviate in color and design from our samples.

Lucca

1. Top 15.75" x d 18.70", fixed height 22.44"

List prices

	Code	Handle	
		Ash	Walnut
Dim.: w 15.75" x d 18.70" x h 22.44" Tops with knife edge, 0.63" thick of which 0.4" straight edge 6 kg			

1.1. Base and top powdercoated in the same color

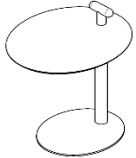

Base and top white	LUCSTFI01 *	885	935
Base and top nude	LUCSTFINU *	885	935
Base and top grey-green	LUCSTFIGG *	885	935
Base and top yellow	LUCSTFI21 *	885	935

1.2. Powdercoated base with Fenix hpl top

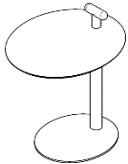

Black base, Fenix hpl top	LUCSTFI04 * **	900	950
White base, Fenix hpl top	LUCSTFI01 * **	900	950

1.3. Powdercoated base with veneer top

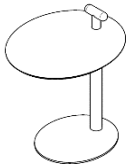

Black base, veneer top	LUCSTFI04 * **	1.275	1.325
White base, veneer top	LUCSTFI01 * **	1.275	1.325

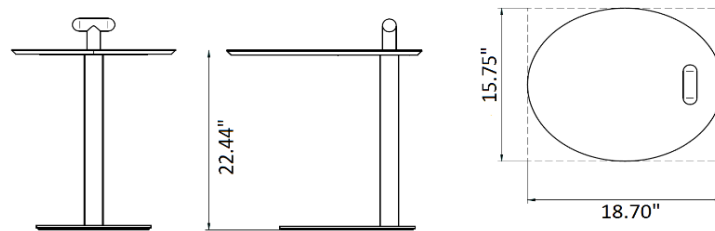

FINISHES & CODES

* Solid wooden handle

AN	Ash, natural
AB	Ash, black lacquered
WA	Walnut, natural

** Top

0.63" hpl Fenix black mdf chamfered edges		0.63" veneer black mdf chamfered edges	
16F1	white 0029	16ES	ash natural
16F2	beige Arizona 0748	16NN	walnut
16F3	grigio bromo 0724	16EZ	black lacquered ash
16F4	black 0720		
16F6	blue fes 0754		
16F7	verde comodoro 0750		
16F8	beige luxor 0719		
16F9	rosso jaipur 0751		

Code example: LUCSTFI01AN = 885

Lucca

2. Top 15.74" x 20.87", fixed height 26.3"

List prices

	Code	Handle	
		Ash	Walnut
Dim.: w 15.74" x d 20.87" x h 26.3"			
Tops with knife edge, 0.63" thick of which 0.4" straight edge			
7 kg			

2.1. Base and top powdercoated in the same color

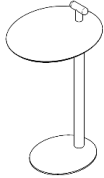

Base and top white	LUCLAFI01 *	925	975
Base and top nude	LUCLAFINU *	925	975
Base and top grey-green	LUCLAFIGG *	925	975
Base and top yellow	LUCLAFI21 *	925	975

2.2. Powdercoated base with Fenix hpl top

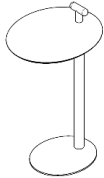

Black base, Fenix hpl top	LUCLAFI04 * **	940	990
White base, Fenix hpl top	LUCLAFI01 * **	940	990

2.3. Powdercoated base with veneer top

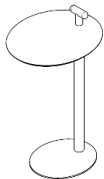

Black base, veneer top	LUCLAFI04 * **	1.315	1.365
White base, veneer top	LUCLAFI01 * **	1.315	1.365

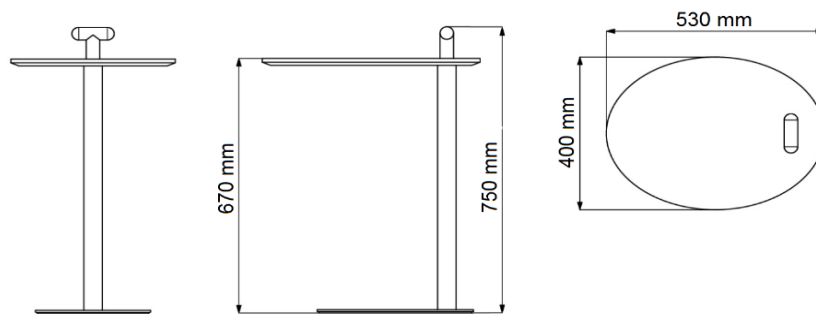

FINISHES & CODES

* Solid wooden handle

AN	Ash, natural
AB	Ash, black lacquered
WA	Walnut, natural

** Top

0.63" hpl Fenix black mdf chamfered edges		0.63" veneer black mdf chamfered edges	
16F1	white 0029	16ES	ash natural
16F2	beige Arizona 0748	16NN	walnut
16F3	grigio bromo 0724	16EZ	black lacquered ash
16F4	black 0720		
16F6	blue fes 0754		
16F7	verde comodoro 0750		
16F8	beige luxor 0719		
16F9	rosso jaipur 0751		

Code example: LUCLAFI01AN = 925

Lucca

3. Top 15.75" x d 18.70", height adjustable 18.50"/26.38"

List prices

Handle	Code	Top		
		Powdercoat	Fenix hpl	Veneer
Dim.: w 15.75" x d 18.70" x h 18.50"/26.38"				
The height adjustable table can be set on 2 positions: either 18.50" or 26.38" high. No intermediate positions.				
Tops with knife edge, 0.63" thick of which 0.4" straight edge				
8 kg				

3.1. Column base and foot in black RAL 9005

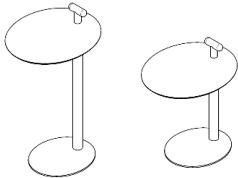

Natural ash wood	LUCSTHA04AN *	1.115	1.310	1.690
Black lacquered ash wood	LUCSTHA04AB *	1.115	1.310	1.690
Natural walnut wood	LUCSTHA04WA *	1.165	1.360	1.740

3.2. Column base and foot in white RAL 9010

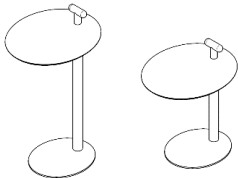

Natural ash wood	LUCSTHA01AN *	1.115	1.310	1.690
Black lacquered ash wood	LUCSTHA01AB *	1.115	1.310	1.690
Natural walnut wood	LUCSTHA01WA *	1.165	1.360	1.740

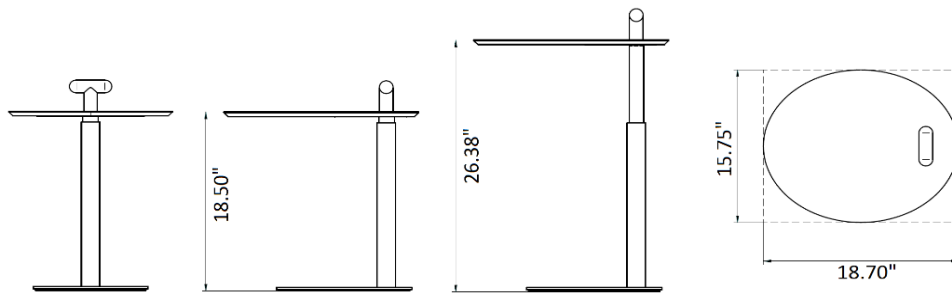

FINISHES & CODES

* Solid wooden handle

AN	Ash, natural
AB	Ash, black lacquered
WA	Walnut, natural

** Top

0.63" hpl Fenix black mdf chamfered edges		0.63" veneer black mdf chamfered edges	
16F1	white 0029	16ES	ash natural
16F2	beige Arizona 0748	16NN	walnut
16F3	grigio bromo 0724	16EZ	black lacquered ash
16F4	black 0720		
16F6	blue fes 0754		
16F7	verde comodoro 0750		
16F8	beige luxor 0719		
16F9	rosso jaipur 0751		

Code example: LUCSTHA04AN16F4 = 1.310

Lucca

4. Colors and materials

POWDERCOAT



White
RAL9010



Grey-green
RAL7003

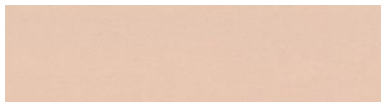

Nude
Pantone 15-1315 tpx Pink

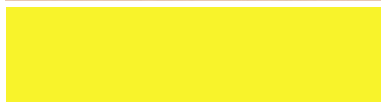

Broom yellow
RAL1032



Black
RAL9005
(for base only)

FENIX HPL



Lily white 0029



Beige Arizona 0748



Grigio bromo 0724

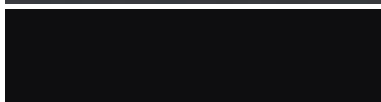

Black 0720



Blu fes 0754



Verde comodoro 0750



Beige luxor 0719



Rosso jaipur 0751

VENEER



Natural ash



Walnut

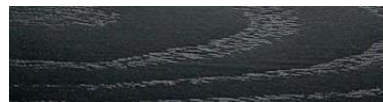

Black lacquered ash

SOLID WOOD



Natural ash



Walnut



Black lacquered ash

Monica

by Bulo Design in collab with Gensler



Monica

by Bulo Design in collab with Gensler

Gensler is a global architecture, design and planning firm with 50 locations and more than 6000 professionals networking across the world.

Founded in 1965, the firm serves more than 3500 active clients in virtually every industry. Gensler supports clients at every stage of the design cycle. In 2019 Bulo and Gensler teamed up to design this lounge collection.

Monica and Lucca are quintessential Bulo. Both timeless and contemporary, they feel at home in different interiors. Classical woodworking and upholstery is combined with state-of-the-art production techniques.

Monica is a soft lounge chair with a solid wooden base and a 'draped' upholstered soft shell resting on it. The duality of the chair is based on contrasts between hard and soft, static and fluid. It's almost as if she is tempting gravity with a soft skin that is hanging over a rigid wooden skeleton. Wood is in Bulo's DNA, so it was an obvious choice to leave the beautifully shaped wooden details visible. Monica is a contemporary piece with vintage look that's well adapted to the technicality and comfort of today.

Technical information:

Monica is available on 4 solid wooden legs or on a 4-star base

Solid wood: ash, black lacquered ash or walnut.

4-star base: black lacquered

We point out that wood is a natural material.

In products where veneer or solid wood is applied it is therefore possible that there is variation in color and grain within one order with multiple of these products in the same veneer or solid wood, or even within one product.

Our wood samples are made from another tree than the final product. This means that the veneer or solid wood in the final products can deviate in color and design from our samples.

With the use of COM or COL, even if Bulo accepted the order, there is no guarantee on the fabric or leather, its behavior on the chair or sofa after either short or long term use, nor on pilling or creasing. Our standard guarantee applies to the unupholstered parts of the product only. Bulo can not be held responsible for the fact that light colors tend to get dirty rather quickly.

COM: price category 1. COM required:

Textile width 1,53 yards/55" : | 3,1 yards/110" required

Textile width 1,42 yards/54" : | 3,4 yards/122" required

COL: price category 2. COL required: 1 hide per chair (+/- 60 ft²)

Monica

1. On 4 wooden legs

List prices

Code	Fabric							Leather	
	Cat. 1	Cat. 2	Cat. 3	Cat. 4	Cat. 5	Cat. 6	Cat. 7		
Dim.: w 32.68" x d 28.75" x h 28.35". Seating height: 16.54" On universal glides Weight: 32 kg									
Natural ash wood	MONLOCHAN * F	3.160	3.325	3.495	3.665	3.830	5.450	7.995	4.715
Black lacquered ash wood	MONLOCHAB * F	3.160	3.325	3.495	3.665	3.830	5.450	7.995	4.715
Natural walnut wood	MONLOCHWA * F	3.510	3.675	3.845	4.015	4.180	5.800	8.345	5.065

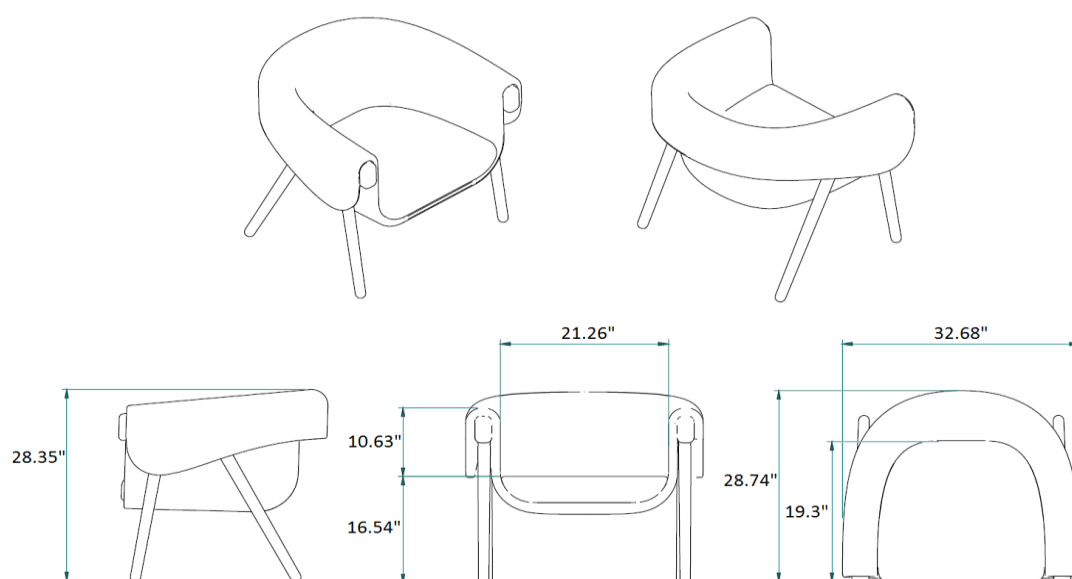

* FINISHES & CODES

Fabric cat. 1	Fabric cat. 3	Fabric cat. 4	Fabric cat. 5	Leather	
QU... Quest	BL... Blazer	AR... Arco	HA... Hallingdal 65	LE49000	Black
	KEAT... Atom (Kent)	CL... Cleo	CT... Steelcut 3	LE42008	Dark Brown
Fabric cat. 2	KECA... Castle (Kent)	CR... Credo	TR... Steelcut Trio 3	LE43010	Forest Green
CE... César	KEHU... Hulk (Kent)	EN... Encircle	VI... Vidar 4	LE41004	Sand Grey
CO... Comeback	LALO... Lobo	SH... Shake		LE42006	Tobacco Brown
EX... Extrema AU (+)	ME... Meld	TP... Topia	Fabric cat. 6		
MLF... Main Line Flax	MR... Merit		JUDCR Judith Crème		
RN... Renew	RW... Re-wool		Fabric cat. 7		
			LOUCR Louison Crème		

... = add fabric color code

(+) = 4 colors available: 2250 black, 4550 light blue, 1550 petrol and 4450 mushroom

Code example: MONLOCHANMLF62F = 3.325

Monica

2. On black 4-star base

List prices

Code	Fabric							Leather	
	Cat. 1	Cat. 2	Cat. 3	Cat. 4	Cat. 5	Cat. 6	Cat. 7		
Dim.: w 32.68" x d 28.75" x h 28.35". Seating height: 16.54"									
On felt glides									
Weight: 32 kg									
Natural ash wood	MONLOS4AN * F	3.355	3.525	3.690	3.860	4.025	5.645	8.190	4.910
Black lacquered ash wood	MONLOS4AB * F	3.355	3.525	3.690	3.860	4.025	5.645	8.190	4.910
Natural walnut wood	MONLOS4WA * F	3.705	3.875	4.040	4.210	4.375	5.995	8.540	5.260

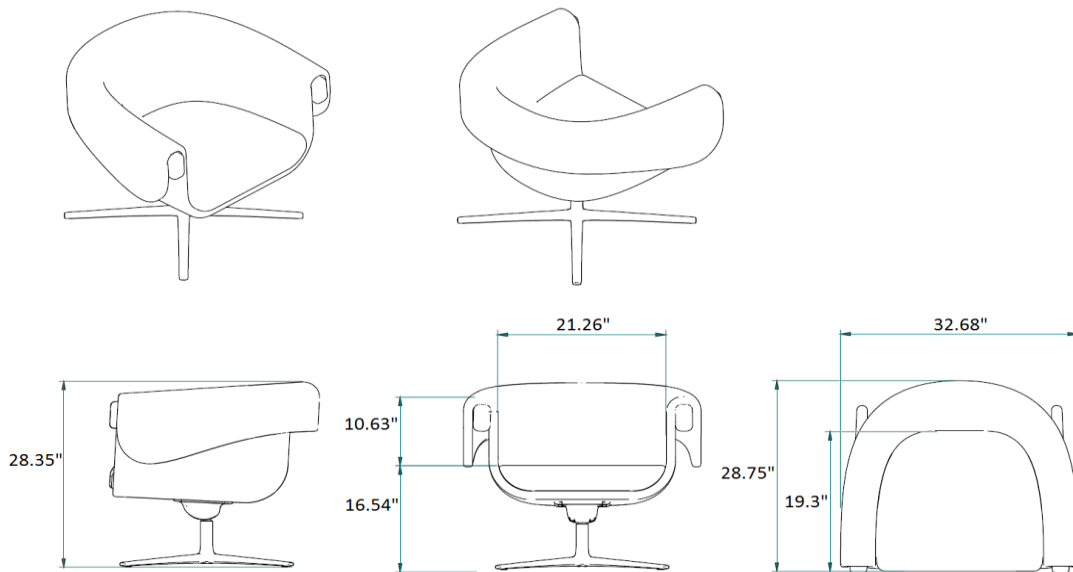

FINISHES & CODES

Fabric cat. 1	Fabric cat. 3	Fabric cat. 4	Fabric cat. 5	Leather
QU... Quest	BL... Blazer	AR... Arco	HA... Hallingdal 65	LE49000 Black
	KEAT... Atom (Kent)	CL... Cleo	CT... Steelcut 3	LE42008 Dark Brown
Fabric cat. 2	KECA... Castle (Kent)	CR... Credo	TR... Steelcut Trio 3	LE43010 Forest Green
CE... César	KEHU... Hulk (Kent)	EN... Encircle	VI... Vidar 4	LE41004 Sand Grey
CO... Comeback	LALO... Lobo	SH... Shake		LE42006 Tobacco Brown
EX... Extrema AU (+)	ME... Meld	TP... Topia	Fabric cat. 6	
MLF... Main Line Flax	MR... Merit		JUDCR Judith Crème	
RN... Renew	RW... Re-wool		Fabric cat. 7	
			LOUCR Louison Crème	

... = add fabric color code

(+) = 4 colors available: 2250 black, 4550 light blue, 1550 petrol and 4450 mushroom

Code example: MONLOS4ANMLF62 = 3.525

Monica

3. Monica Dubbel - 2-seater sofa

List prices

Code	Fabric							Leather	
	Cat. 1	Cat. 2	Cat. 3	Cat. 4	Cat. 5	Cat. 6	Cat. 7		
Dim.: w 58.27" x d 28.75" x h 28.35". Seating height: 16.54" On universal glides Weight: 75 kg									
Natural ash wood	MONSODUAN * F	5.870	6.230	6.595	6.955	7.320	10.020	16.305	9.220
Black lacquered ash wood	MONSODUAB * F	5.870	6.230	6.595	6.955	7.320	10.020	16.305	9.220
Natural walnut wood	MONSODUWA * F	6.625	6.985	7.350	7.710	8.075	10.775	17.060	9.975

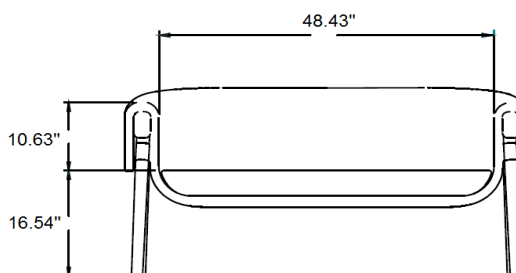
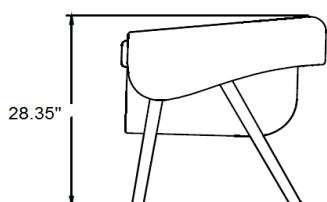
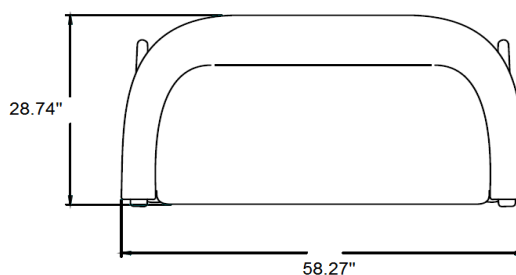
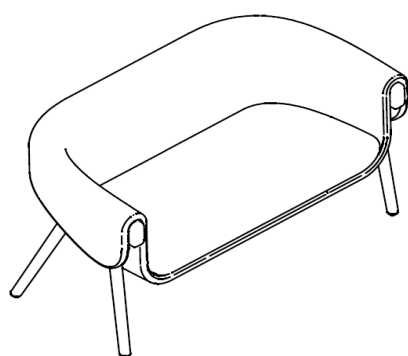

FINISHES & CODES

Fabric cat. 1

QU... Quest

Fabric cat. 2

CE... César

CO... Comeback

EX... Extrema AU (+)

MLF... Main Line Flax

RN... Renew

Fabric cat. 3

BL... Blazer

KEAT... Atom (Kent)

KECA... Castle (Kent)

KEHU... Hulk (Kent)

LALO... Lobo

ME... Meld

MR... Merit

RW... Re-wool

Fabric cat. 4

AR... Arco

CL... Cleo

CR... Credo

EN... Encircle

SH... Shake

TP... Topia

Fabric cat. 5

HA... Hallingdal 65

CT... Steelcut 3

TR... Steelcut Trio 3

VI... Vidar 4

Fabric cat. 6

JUDCR Judith Crème

Fabric cat. 7

LOUCR Louison Crème

Leather

LE49000

LE42008

LE43010

LE41004

LE42006

Black

Dark Brown

Forest Green

Sand Grey

Tobacco Brown

... = add fabric color code

(+) = 4 colors available: 2250 black, 4550 light blue, 1550 petrol and 4450 mushroom

Code example: MONSODUANMLF62F · 6.230

Monica

4. Colors and materials

SOLID WOOD



Solid ash wood
black lacquered



Solid ash wood
natural varnished



Solid walnut wood
natural varnished

4-STAR BASE



Black

Pub&Club

by Luc Vincent & Bulo Design



Pub&Club

by Luc Vincent & Bulo Design

With soft cushions and broad armrests Pub & Club transcends the functional aspect of the desk chair to luxurious comfort and playful aesthetics. Pub & Club is the perfect antidote to the rigid office chair, making working cosy and warm with a touch of lounge.

TECHNICAL INFORMATION

Pub&Club model TwentyOne (TO) as from July 2021: new mechanism and castors compared to the previous -New Generation- model. Desk chair always with sliding seat. All chairs with universal castors for all types of floors.

Desk chairs

Dim.: w 22.05" x d 19.49" x h 33.86" - 38.98"

Adjustable seat height, adjustment for weight, fixation of synchronous mechanism, sliding seat.

5-star swivel base, diam. 25.59", in chrome, black or aluminium color, on universal castors

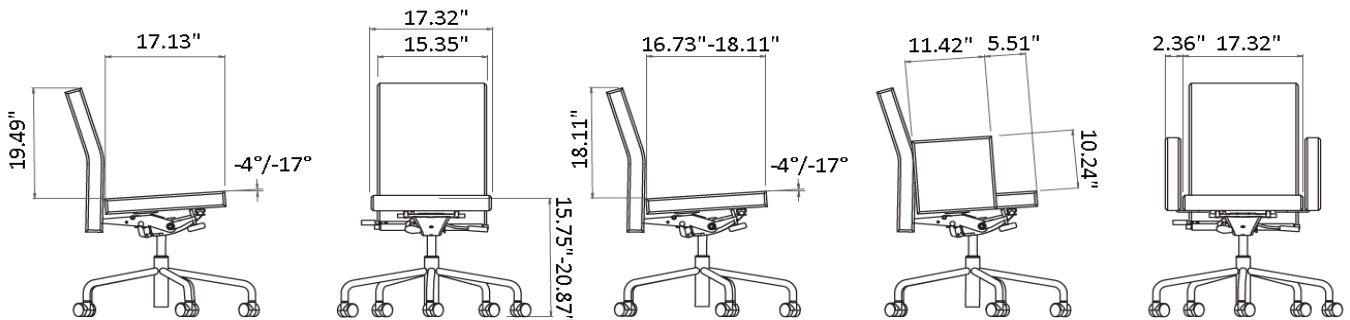

Visitor's chairs

Dim.: w 22.05" x d 19.49" x h 36.22"/37.40"

Fixed height

5-star swivel base, diam. 25.59", in chrome, black or aluminium color, on universal castors

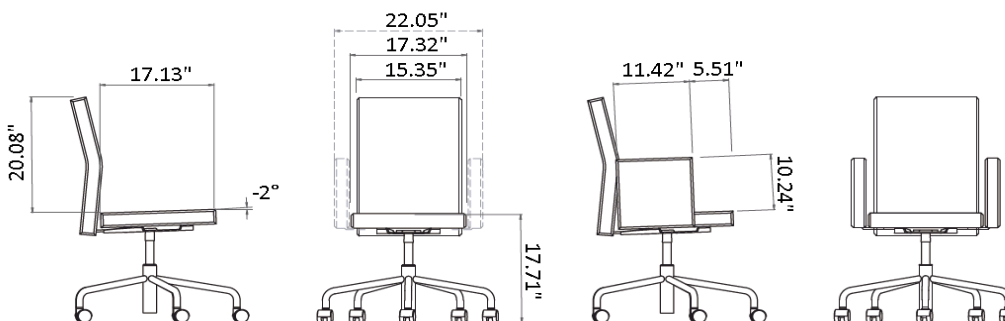

Types of arm rests:

- no arm rests (Pub)
- square upholstered arm rests (Club), adjustable in width

Spare parts

Pub&Club model TwentyOne (TO) as from July 2021: spare parts available on request

Pub&Club model New Generation (NG) from 2007 to July 2021. Spare parts available till end of stock on request.

Pub&Club model Classics till 2007: no spare parts available anymore.

When ordering spare parts, please always include an image of the label underneath the seat.

Castors

Castors with a pin if 0.39" diameter are not available anymore

NET PRICES

ZIC PCWIHAZW	1 hard castor for carpet floor, pin 11mm diameter	23
ZIC PCWIZAZW	1 soft castor for hard floors or wooden floors, pin 11mm diameter	27

Pub&Club

List prices

	Code	Fabric				Leather
		Cat. 2	Cat. 3	Cat. 4	Cat. 5	
Universal castors, suited for all types of floors						
All desk chairs with sliding seat						

1. Club, with arm rests

Desk chair



Base black	CLBTO412 *	3.190	3.320	3.460	3.580	4.980
Base aluminium color	CLBTO432 *	3.190	3.320	3.460	3.580	4.980
Base chrome	CLBTO422 *	3.460	3.590	3.725	3.850	5.250

Visitor's chair



Base black	CLBTO112 *	2.910	3.040	3.190	3.305	4.705
Base aluminium color	CLBTO132 *	2.910	3.040	3.190	3.305	4.705
Base chrome	CLBTO122 *	3.180	3.310	3.460	3.570	4.975

2. Pub, without arm rests

Desk chair



Base black	PUBTO410 *	2.735	2.845	2.960	3.040	3.620
Base aluminium color	PUBTO430 *	2.735	2.845	2.960	3.040	3.620
Base chrome	PUBTO420 *	3.000	3.115	3.230	3.310	3.890

Visitor's chair



Base black	PUBTO110 *	2.455	2.570	2.685	2.765	3.345
Base aluminium color	PUBTO130 *	2.455	2.570	2.685	2.765	3.345
Base chrome	PUBTO120 *	2.725	2.840	2.955	3.035	3.615

* FINISHES & CODES

Fabric cat. 2	Fabric cat. 3	Fabric cat. 4	Fabric cat. 5	Leather
Corduroy	BL... Blazer	AR... Arco	HA... Hallingdal 65	31 black
81 red (+)	MR... Merit	CL... Cleo	CT... Steelcut 3	
82 grey (+)	RW... Re-wool	CR... Credo	TR... Steelcut Trio 3	
83 blue (+)		SH... Shake	VI... Vidar 4	
85 burgundy (+)		TP... Topia		
MLF... Main Line Flax				

... = add fabric color code
(+) until end of stock

Code example: CLBTO41281 = 3.190

Pub&Club

Colors and materials

BASE



Black



Aluminium color



Chrome

Skater

by Hannes Wettstein



Skater

by Hannes Wettstein

Inspired by skateboards, the Skater is a simple and informal seating designed by Hannes Wettstein.

TECHNICAL INFORMATION



Material : multiply, finished in HPL lily white, HPL black or maple veneer

Visible multiply edges

Dim.: w 20.31" x d 9.72" x h 15.71"/18.15"

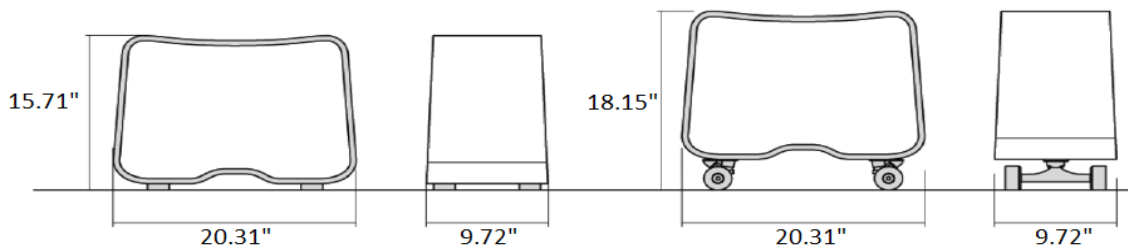
6 kg



	Multiply finish	Code	List prices
1. On glides			
	HPL lily white	DYSKRD01	815
	HPL black	DYSKRD04	815
	Maple veneer	DYSKRDED	1 080
2. On skateboard castors			
	HPL lily white	DYSKWI01	1 080
	HPL black	DYSKWI04	1 080
	Maple veneer	DYSKWIED	1 325

COLORS AND MATERIALS



HPL lily white



HPL black



Maple veneer
(until stock ends)

Digital or paper printing is not binding

SL

by Léon Stynen



Fosbury & Sons Boitsfort

SL58

by Léon Stynen

SL58

SL58 is a re-edition of a chair created in 1958 by Belgian modernist architect, Léon Stynen. A design beautifully reduced to pure simplicity and continuity, the SL58 is a timeless classic.

The shell is made out of beech plywood. Steel base.

TECHNICAL INFORMATION

On 4 legs

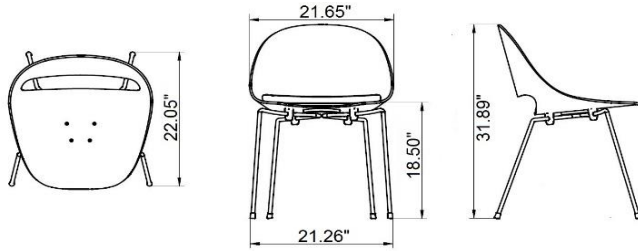

Lounge chair



Visitor's chair on 4-star trestle base on castors

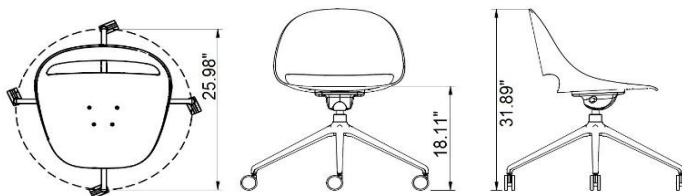

Visitor's chair on 4-star trestle base on glides



SL58

by Léon Stynen

Desk chair on 5-star trestle base on castors

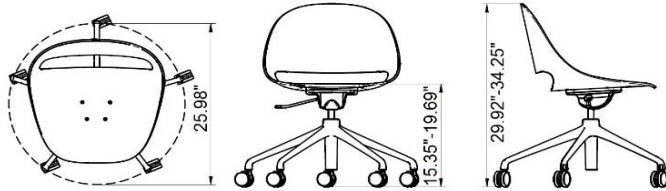

High bar stool

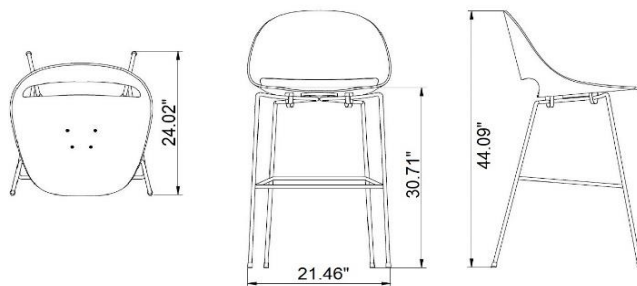

Middle high bar stool



SL58

1. Chair on 4 legs

List prices

Wooden shell			Fabric							Leather
Base	Code	Wood	Cat. 1	Cat. 2	Cat. 3	Cat. 4	Cat. 5	Cat. 6	Cat. 7	

1.1. Chair
w 21.65" x d 22.05" x h 31.89", seat height 18.50"
On anti-skid glides



Black	SL58CH04 * F	800	1.260	1.370	1.480	1.585	1.700	2.185	3.940	2.040
Lily white	SL58CH01 * F	800	1.260	1.370	1.480	1.585	1.700	2.185	3.940	2.040
Chrome	SL58CHCH * F	800	1.260	1.370	1.480	1.585	1.700	2.185	3.940	2.040
Champagne	SL58CH17 * F	865	1.325	1.435	1.535	1.640	1.765	2.230	4.005	2.095

1.2. Lounge chair
w 21.65" x d 21.06" x h 27.95", seat height 15.75"
On anti-skid glides



Black	SL58LO04 * F	815	1.275	1.390	1.495	1.600	1.715	2.185	3.955	2.055
Lily white	SL58LO01 * F	815	1.275	1.390	1.495	1.600	1.715	2.185	3.955	2.055
Chrome	SL58LOCH * F	815	1.275	1.390	1.495	1.600	1.715	2.185	3.955	2.055
Champagne	SL58LO17 * F	885	1.340	1.455	1.550	1.655	1.780	2.230	4.020	2.115

* FINISHES & CODES

Wood	Upholstery			
BN000 natural beech	Fabric cat. 1	Fabric cat. 3	Fabric cat. 4	Fabric cat. 6
BD000 stained in santos rose wood color	QU... Quest	BL... Blazer KEAT... Atom (Kent)	AR... Arco CA... Canvas 2	JUDCR Judith Crème
	Fabric cat. 2	KECA... Castle (Kent) KEHU... Hulk (Kent)	CL... Cleo CR... Credo	Fabric cat. 7 LOUCR Louison Crème
	CE... César CO... Comeback EX... Extrema AU (+)	LALO... Lobo ME... Meld	EN... Encircle SH... Shake	Leather
	MLF... Main Line Flax RN... Renew	MR... Merit RE... Remix 3 RW... Re-wool	TP... Topia	LE49000 Black LE42008 Dark Brown LE43010 Forest Green LE41004 Sand Grey LE42006 Tobacco Brown
			Fabric cat. 5 HA... Hallingdal 65 CT... Steelcut 3 TR... Steelcut Trio 3 VI... Vidar 4	

... = add fabric color code

(+) = 4 colors available: 2250 black, 4550 light blue, 1550 petrol and 4450 mushroom

Code example: SL58CH04BN000F = 800

SL58

2. Chair on trestle base

List prices

Wooden shell

Code	Wood	Fabric							Leather
		Cat. 1	Cat. 2	Cat. 3	Cat. 4	Cat. 5	Cat. 6	Cat. 7	

2.1. Office chair

Black 5-star swivel trestle base.
Adjustable seat height, 15.35" - 19.69"
w 25.98" x d 25.98" x h 29.92"-34.25"
Black universal pvc castors diam. 2.56"



SL58DC04 * C	1.330	1.790	1.900	2.010	2.115	2.230	2.715	4.470	2.570
---------------------	-------	--------------	-------	-------	-------	-------	-------	-------	-------

2.2. Visitor's chair on castors

Black 4-star swivel trestle base.
Fixed height. Seat height 18.11"
w 25.98" x d 25.98" x h 31.89"
Black universal pvc castors diam. 2.56"



SL58VC04 * C	1.070	1.530	1.640	1.750	1.855	1.970	2.455	4.210	2.310
---------------------	-------	-------	-------	-------	-------	-------	-------	-------	-------

2.3. Visitor's chair on glides

Black 4-star swivel trestle base.
Fixed height. Seat height 18.11"
w 25.98" x d 25.98" x h 31.89"
On felt glides



SL58VC04 * F	960	1.420	1.530	1.640	1.745	1.860	2.345	4.100	2.200
---------------------	-----	-------	-------	-------	-------	-------	-------	-------	-------

* FINISHES & CODES

Wood

BN000 natural beech
BD000 stained in santos
rose wood color

Upholstery

Fabric cat. 1	Fabric cat. 3	Fabric cat. 4	Fabric cat. 6
QU... Quest	BL... Blazer	AR... Arco	JUDCR Judith Crème
	KEAT... Atom (Kent)	CA... Canvas 2	
Fabric cat. 2	KECA... Castle (Kent)	CL... Cleo	Fabric cat. 7
CE... César	KEHU... Hulk (Kent)	CR... Credo	LOUCR Louison Crème
CO... Comeback	LALO... Lobo	EN... Encircle	
EX... Extrema AU (+)	ME... Meld	SH... Shake	Leather
MLF... Main Line Flax	MR... Merit	TP... Topia	LE49000 Black
RN... Renew	RE... Remix 3		LE42008 Dark Brown
	RW... Re-wool	Fabric cat. 5	LE43010 Forest Green
		HA... Hallingdal 65	LE41004 Sand Grey
		CT... Steelcut 3	LE42006 Tobacco Brown
		TR... Steelcut Trio 3	
		VI... Vidar 4	

... = add fabric color code

(+) = 4 colors available: 2250 black, 4550 light blue, 1550 petrol and 4450 mushroom

Code example: SL58DC04CO45C = 1.790

SL58

3. Bar stool

List prices

Wooden shell		Fabric									Leather
Base	Code	Wood	Cat. 1	Cat. 2	Cat. 3	Cat. 4	Cat. 5	Cat. 6	Cat. 7		
3.1. High bar stool w 21.65" x d 24.03" x h 44.09" Seat height 30.71" Anti skid glides											
											
Black	SL58BS04 * F	995	1.455	1.565	1.675	1.780	1.895	2.380	4.135	2.235	
Chrome	SL58BSCH * F	995	1.455	1.565	1.675	1.780	1.895	2.380	4.135	2.235	

3.2. Counter height stool
w 21.65" x d 21.26" x h 38.19"
Seat height 25.39"
Anti skid glides



Black	SL58LB04 * F	995	1.455	1.565	1.675	1.780	1.895	2.380	4.135	2.235
Chrome	SL58LBCH * F	995	1.455	1.565	1.675	1.780	1.895	2.380	4.135	2.235

* FINISHES & CODES

Wood	Upholstery			
BN000 natural beech	Fabric cat. 1	Fabric cat. 3	Fabric cat. 4	Fabric cat. 6
BD000 stained in santos rose wood color	QU... Quest	BL... Blazer	AR... Arco	JUDCR Judith Crème
	Fabric cat. 2	KEAT... Atom (Kent)	CA... Canvas 2	Fabric cat. 7
	CE... César	KECA... Castle (Kent)	CL... Cleo	LOUCR Louison Crème
	CO... Comeback	KEHU... Hulk (Kent)	CR... Credo	
	EX... Extrema AU (+)	LALO... Lobo	EN... Encircle	
	MLF... Main Line Flax	ME... Meld	SH... Shake	Leather
	RN... Renew	MR... Merit	TP... Topia	LE49000 Black
		RE... Remix 3		LE42008 Dark Brown
		RW... Re-wool	Fabric cat. 5	LE43010 Forest Green
			HA... Hallingdal 65	LE41004 Sand Grey
			CT... Steelcut 3	LE42006 Tobacco Brown
			TR... Steelcut Trio 3	
			VI... Vidar 4	

... = add fabric color code

(+) = 4 colors available: 2250 black, 4550 light blue, 1550 petrol and 4450 mushroom

Code example: SL58BS04BD000F = 995

SL58

4. Colors and materials

WOODEN SHELL



Beech plywood
natural

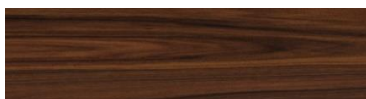

Beech plywood
santos rosewood
stained

BASE



Chrome



Champagne



White
Ral 9010
powdercoated



Black
Ral 9005
powdercoated

Digital or paper printing is not binding

SLL18

by Léon Stynen

SLL18

SLL18 is the polypropylene version of SL58.

The chair on 4 legs is stackable up till 4 pieces in unupholstered version.
All chairs are for indoor use only.

TECHNICAL INFORMATION

On 4 legs

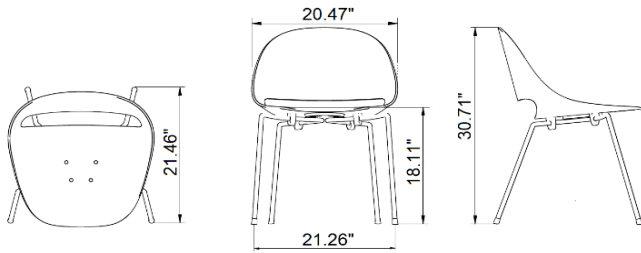

Lounge chair

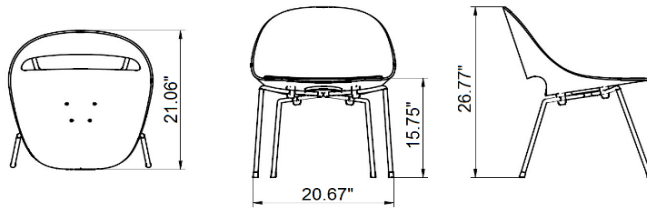

Visitor's chair on 4-star trestle base on castors

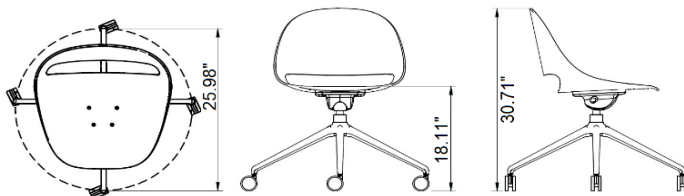

Visitor's chair on 4-star trestle base on glides

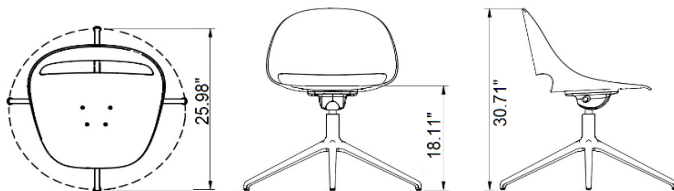

SLL18

by Léon Stynen

Desk chair on 5-star trestle base on castors

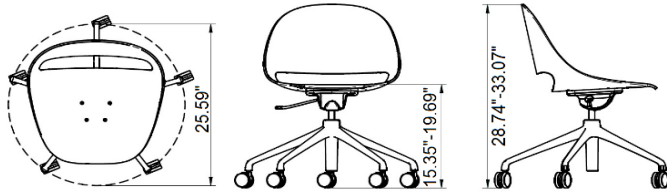

High bar stool

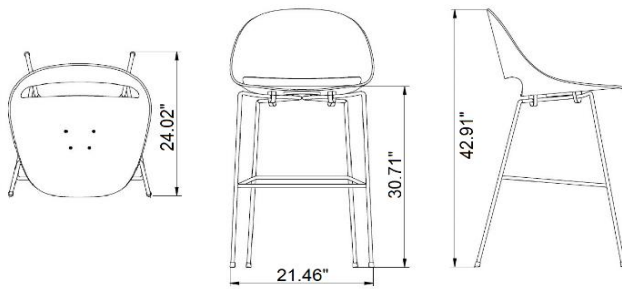

Middle high bar stool

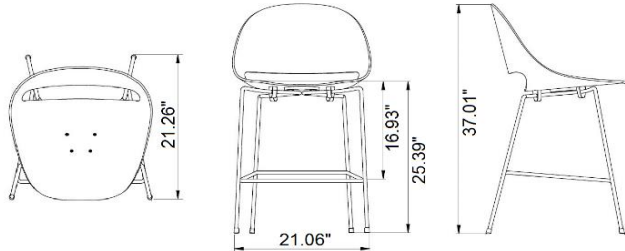

SLL18

1. Chair on 4 legs

List prices

Polypropylene shell

Base	Code	Polyprop.	Fabric						
			Cat. 1	Cat. 2	Cat. 3	Cat. 4	Cat. 5	Cat. 6	Cat. 7

1.1. Chair.
w 21.26" x d 21.46" x h 30.71". Seat height 18.11".
On anti-skid glides
Unupholstered chair stackable till 4 pieces.



Black	SL18CHPI04 *	490	1.040	1.120	1.225	1.330	1.435	2.170	3.530
-------	---------------------	------------	-------	-------	-------	-------	-------	-------	-------

Monocolors - base and shell in the same color:

White	SL18CHPI0101	615
Grey-green	SL18CHPIGGGG	615
Nude	SL18CHPINUNU	615

1.2. Lounge chair
w.525 x d 21.06" x h 26.77", seat height 15.75"
On anti-skid glides



Black	SL18LOPI04 *	475	1.020	1.105	1.210	1.315	1.410	2.155	3.515
-------	---------------------	------------	-------	-------	-------	-------	-------	-------	-------

* FINISHES & CODES

Polypropylene

01 white
04 black
CH cherry red
GG grey-green
NU nude
OR orange
PE petrol

Upholstery

Fabric cat. 1	Fabric cat. 3	Fabric cat. 4	Fabric cat. 6
QU... Quest	BL... Blazer	AR... Arco	JUDCR Judith Crème
	KEAT... Atom (Kent)	CA... Canvas 2	
Fabric cat. 2	KECA... Castle (Kent)	CL... Cleo	Fabric cat. 7
CE... César	KEHU... Hulk (Kent)	CR... Credo	LOUCR Louison Crème
CO... Comeback	LALO... Lobo	EN... Encircle	
EX... Extrema AU (+)	ME... Meld	SH... Shake	Leather
MLF... Main Line Flax	MR... Merit	TP... Topia	LE49000 Black
RN... Renew	RE... Remix 3		LE42008 Dark Brown
	RW... Re-wool	Fabric cat. 5	LE43010 Forest Green
		HA... Hallingdal 65	LE41004 Sand Grey
		CT... Steelcut 3	LE42006 Tobacco Brown
		TR... Steelcut Trio 3	
		VI... Vidar 4	

... = add fabric color code

(+) = 4 colors available: 2250 black, 4550 light blue, 1550 petrol and 4450 mushroom



Code example: SL18CHPI04NU = 490

SLL18

2. Chair on trestle base

List prices

Polypropylene shell

Code	Polyprop.	Fabric							
		Cat. 1	Cat. 2	Cat. 3	Cat. 4	Cat. 5	Cat. 6	Cat. 7	
2.1. Office chair Black 5-star swivel trestle base. Adjustable seat height, 15.35" - 19.69" w 25.98" x d 25.98" x h 28.74"-33.07 Black universal pvc castors diam. 2.56"									
 SL18DCPI04 * C	1.020	1.570	1.650	1.755	1.860	1.965	2.700	4.060	
2.2. Visitor's chair on castors Black 4-star swivel trestle base. Fixed height. Seat height 18.11" w 25.98" x d 25.98" x h 30.71" Black universal pvc castors diam. 2.56"									
 SL18VCPI04 * C	760	1.310	1.390	1.495	1.600	1.705	2.440	3.800	
2.3. Visitor's chair on glides Black 4-star swivel trestle base. Fixed height. Seat height 18.11" w 25.98" x d 25.98" x h 30.71" On felt glides									
 SL18VCPI04 * F	650	1.200	1.280	1.385	1.490	1.595	2.330	3.690	

* FINISHES & CODES

Polypropylene

01 white
04 black
CH cherry red
GG grey-green
NU nude
OR orange
PE petrol

Upholstery

Fabric cat. 1	Fabric cat. 3	Fabric cat. 4	Fabric cat. 6
QU... Quest	BL... Blazer	AR... Arco	JUDCR Judith Crème
Fabric cat. 2	KEAT... Atom (Kent)	CA... Canvas 2	Fabric cat. 7
CE... César	KECA... Castle (Kent)	CL... Cleo	LOUCR Louison Crème
CO... Comeback	KEHU... Hulk (Kent)	CR... Credo	Leather
EX... Extrema AU (+)	LALO... Lobo	EN... Encircle	LE49000 Black
MLF... Main Line Flax	ME... Meld	SH... Shake	LE42008 Dark Brown
RN... Renew	MR... Merit	TP... Topia	LE43010 Forest Green
	RE... Remix 3		LE41004 Sand Grey
	RW... Re-wool	Fabric cat. 5	LE42006 Tobacco Brown
		HA... Hallingdal 65	
		CT... Steelcut 3	
		TR... Steelcut Trio 3	
		VI... Vidar 4	

... = add fabric color code

(+) = 4 colors available: 2250 black, 4550 light blue, 1550 petrol and 4450 mushroom

Code example: SL18DCPI04QU01C = 1570

SLL18

3. Bar stool

List prices

Polypropylene shell

Code	Polyprop.	Fabric							
		Cat. 1	Cat. 2	Cat. 3	Cat. 4	Cat. 5	Cat. 6	Cat. 7	

3.1. High bar stool
w 21.46" x d 24.03" x h 42.91"
Seat height 30.71"
Black base
Anti-skid glides



SL18BSP104 *	685	1.235	1.315	1.420	1.525	1.630	2.365	3.725
---------------------	-----	-------	--------------	-------	-------	-------	-------	-------

3.2. Counter height stool
w 21.46" x d 24.03" x h 37.01"
Seat height 25.39"
Black base
Anti-skid glides



SL18LBPI04 *	685	1.235	1.315	1.420	1.525	1.630	2.365	3.725
---------------------	-----	-------	-------	-------	-------	-------	-------	-------

* FINISHES & CODES

Polypropylene	Upholstery			
01 white	Fabric cat. 1	Fabric cat. 3	Fabric cat. 4	Fabric cat. 6
04 black	QU... Quest	BL... Blazer	AR... Arco	JUDCR Judith Crème
CH cherry red		KEAT... Atom (Kent)	CA... Canvas 2	
GG grey-green	Fabric cat. 2	KECA... Castle (Kent)	CL... Cleo	Fabric cat. 7
NU nude	CE... César	KEHU... Hulk (Kent)	CR... Credo	LOUCR Louison Crème
OR orange	CO... Comeback	LALO... Lobo	EN... Encircle	
PE petrol	EX... Extrema AU (+)	ME... Meld	SH... Shake	Leather
	MLF... Main Line Flax	MR... Merit	TP... Topia	LE49000 Black
	RN... Renew	RE... Remix 3		LE42008 Dark Brown
		RW... Re-wool	Fabric cat. 5	LE43010 Forest Green
			HA... Hallingdal 65	LE41004 Sand Grey
			CT... Steelcut 3	LE42006 Tobacco Brown
			TR... Steelcut Trio 3	
			VI... Vidar 4	

... = add fabric color code

(+) = 4 colors available: 2250 black, 4550 light blue, 1550 petrol and 4450 mushroom

Code example: SL18BSP104CO45 = 1315

SL

Cushion

List prices

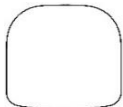
Code	Fabric						
	Cat. 1	Cat. 2	Cat. 3	Cat. 4	Cat. 5	Cat. 6	Cat. 7
Universal cushion for SL58 and SLL18 chair w 15.75" x d 14.17"							
 CUSUNNO *	205	230	265	305	310	615	1.105

* FINISHES & CODES

Upholstery			
Fabric cat. 1	Fabric cat. 3	Fabric cat. 4	Fabric cat. 6
QU... Quest	BL... Blazer	AR... Arco	JUDCR Judith Crème
	KEAT... Atom (Kent)	CA... Canvas 2	
Fabric cat. 2	KECA... Castle (Kent)	CL... Cleo	Fabric cat. 7
CE... César	KEHU... Hulk (Kent)	CR... Credo	LOUCR Louison Crème
CO... Comeback	LALO... Lobo	EN... Encircle	
EX... Extrema AU (+)	ME... Meld	SH... Shake	
MLF... Main Line Flax	MR... Merit	TP... Topia	
RN... Renew	RE... Remix 3		
	RW... Re-wool	Fabric cat. 5	
		HA... Hallingdal 65	
		CT... Steelcut 3	
		TR... Steelcut Trio 3	
		VI... Vidar 4	

... = add fabric color code

(+) = 4 colors available: 2250 black, 4550 light blue, 1550 petrol and 4450 mushroom

Code example: CUSUNNOQU01 = 205

SLL18

4. Colors and materials

BASE



Black lacquered
Ral 9005

MONOCOLOR

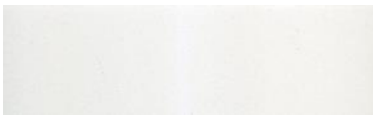

White
Ral 9010



Grey-green
Ral 7003

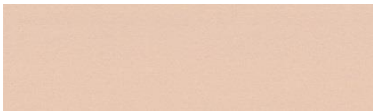

Nude
NCS S2010-Y70R

POLYPROPYLENE SHELL

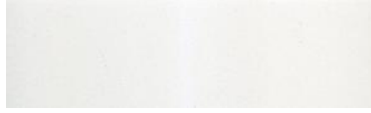

White
Ral 9010



Cherry red
Ral 3003



Grey-green
Ral 7003



Nude
NCS S2010-Y70R



Orange
Ral 2008



Petrol
Ral 6012



Black
Ral 9004

Digital or paper printing is not binding

TAB

by Alain Berteau



TAB Mesh

by Alain Berteau

Tab Mesh is made with a self-supporting shrinking fabric that avoids the necessity for materials like plastic and non-recyclable foams. Using less materials also results in less weight of the end product. This makes the chair highly flexible and ergonomic in use. The Tab mesh chair comes with a tension regulating ring with a tilt angle of 16° and has 3d adjustable armrests. The fabric has a 300 000 martindale abrasion resistance; and passes both cigarette and butane flame test. Other upholstery is not possible on Tab Mesh. Other mesh colors are only possible as from 100 Tab Mesh chairs in one color.

High back task chair

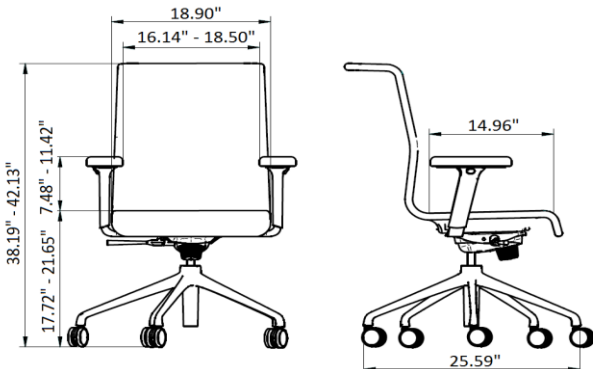

Adjustable seat height
5-star swivel base, black lacquered
on universal castors
Lower tension adjustment; 16° tilt; tilt lock
With or without 3D adjustable arm rests offering
height and depth adjustment and rotation.

Middle high back task chair

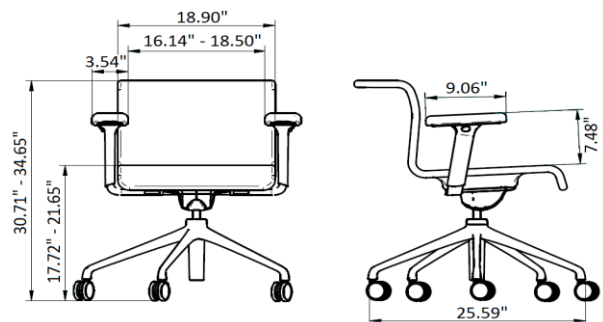

Adjustable seat height
5-star swivel base, black lacquered
on universal castors
16° tilt
With or without 3D adjustable arm rests offering
height and depth adjustment and rotation.

Visitor's chair on glides

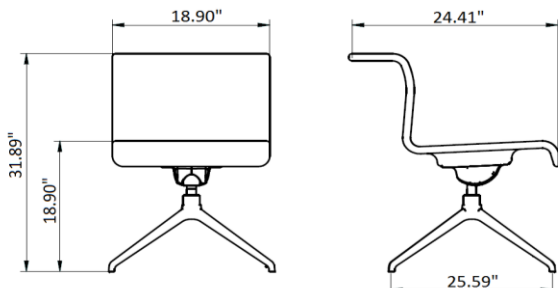

Fixed height
4-star trestle base in polished aluminium or
black lacquered, on universal glides
Base turning circle: 25.6"
With or without 3D adjustable arm rests offering
height and depth adjustment and rotation.

Visitor's chair on castors

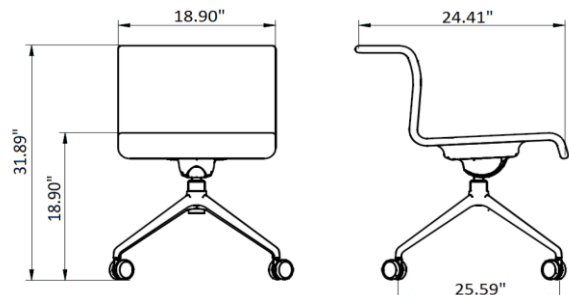

Fixed height
4-star trestle base in polished aluminium or
black lacquered, on universal castors
Base turning circle: 25.6"
With or without 3D adjustable arm rests offering
height and depth adjustment and rotation.

TAB Chair

by Alain Berteau

Tab Chair is a humanistic response to the various ways we like to sit. The back has a flex which makes comfortable and ergonomic seating.

Visitor's chair on sledge base

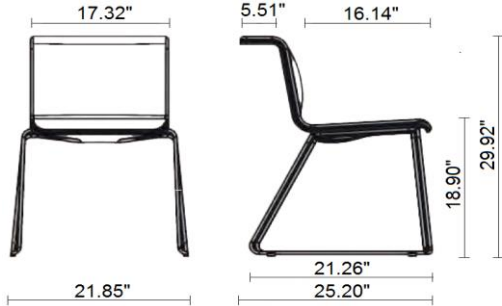

Sledge base in chrome or black lacquered,
on plastic glides or felt glides
Stackable up to 6 chairs
Including 2 interlocking connectors

Visitor's chair on cantilever (until end of stock)

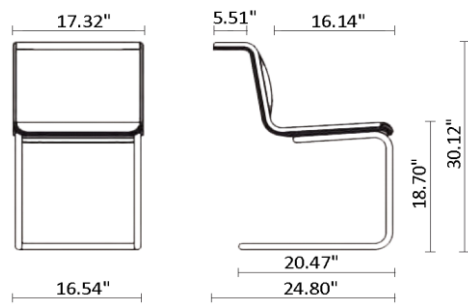

Cantilever base black lacquered,
on plastic glides or felt glides

Bar stool



Base in chrome or black lacquered,
on plastic glides or felt glides

TAB Lounge Chair

by Alain Berteau

Tab Lounge maintains the signature profile whilst offering a more relaxed seating position.



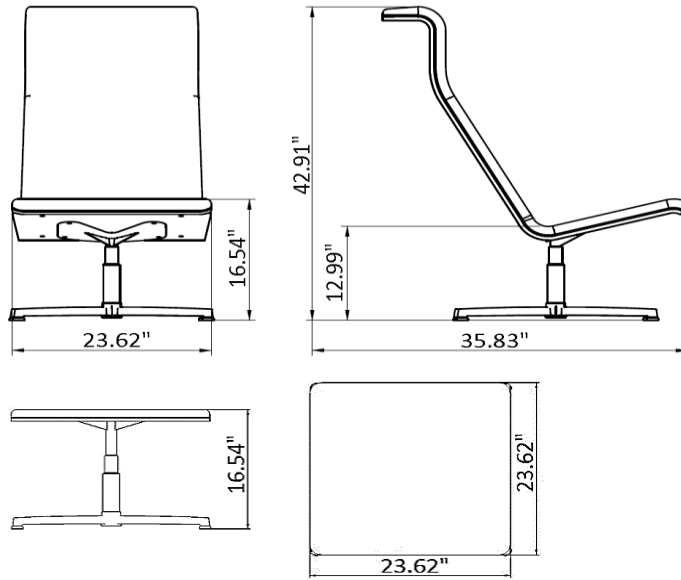

Tab Lounge & Ottoman



4- star swivel base
in polished aluminium or black lacquered
with automatic return mechanism
on felt glides

TAB Mesh

1. TAB Mesh task chair

	Base	Code	List prices
<p>1.1. High back task chair without arm rests on trestle 5-star base on universal castors 12 kg</p> 	Black lacquered	TABMEHBOC0400 * C	1.435
<p>1.2. High back task chair with PU arm rests on trestle 5-star base on castors 15 kg</p> 	Black lacquered	TABMEHBOC04PU * C	1.755
<p>1.3. Middle high task chair without arm rests on trestle 5-star base on castors 9 kg</p> 	Black lacquered	TABMELBOC0400 * C	1.300
<p>1.4. Middle high task chair with PU arm rests on trestle 5-star base on castors 12 kg</p> 	Black lacquered	TABMELBOC04PU * C	1.625





* FINISHES & CODES

Mesh color	
10	black
12	black & white
31	caramel
70	deep sea blue

Example code: TABMEHBOC040012C = 1.435

TAB Mesh

2. TAB Mesh visitor's chair

	Base	Code	List prices
2.1. Visitor's chair without arm rests on trestle 4-star base on castors			
	Black lacquered	TABMELBVC0400 * C	1.225
	Polished aluminium	TABMELBVCPO00 * C	1.225
2.2. Visitor's chair with PU arm rests on trestle 4-star base on castors			
	Black lacquered	TABMELBVC04PU * C	1.550
	Polished aluminium	TABMELBVCPOPU * C	1.550
2.3. Visitor's chair without arm rests on trestle 4-star base on glides			
	Black lacquered	TABMELBVC0400 * G	1.105
	Polished aluminium	TABMELBVCPO00 * G	1.105
2.4. Visitor's chair with PU arm rests on trestle 4-star base on glides			
	Black lacquered	TABMELBVC04PU * G	1.420
	Polished aluminium	TABMELBVCPOPU * G	1.420

* FINISHES & CODES

Mesh color
10 black
12 black & white
31 caramel
70 deep sea blue



Example code: TABMELBVC040031C = 1.225

TAB Chair

To be purchased per pair
List prices are per chair

3. TAB Chair visitor's chairs and bar stool - lacquered back

List prices

Base	Code	Fabric					Leather	
		Cat. 1	Cat. 2	Cat. 3	Cat. 4	Cat. 5		
3.1. Visitor's chair on sledge base on glides Stackable up till 6 chairs								
	Black lacquered plastic glides felt glides	TAB24 * G TAB24 * F	1.020	1.070	1.150	1.225	1.305	1.585
	Chrome plastic glides felt glides	TAB22 * G TAB22 * F	1.055	1.105	1.185	1.260	1.340	1.615
3.2. Visitor's chair on cantilever on glides (until end of stock)								
	Black lacquered plastic glides felt glides	TAB44 * G TAB44 * F	1.185	1.235	1.315	1.390	1.470	1.745
3.3. Bar stool on glides								
	Black lacquered plastic glides felt glides	TAB34 * G TAB34 * F	1.060	1.110	1.190	1.265	1.345	1.625
	Chrome plastic glides felt glides	TAB32 * G TAB32 * F	1.095	1.150	1.225	1.305	1.380	1.655

* FINISHES & CODES

1) Back	2) Upholstery			
01 lily white lacquer	Fabric cat. 1	Fabric cat. 3	Fabric cat. 4	Leather
07 grey-green lacquer	QU... Quest	BL... Blazer	AR... Arco	LE1000 black
06 coffee bean/black lacquer		KEAT... Atom (Kent)	CA... Canvas 2	LE1171 warm grey
10 red lacquer	Fabric cat. 2	KECA... Castle (Kent)	CL... Cleo	LE1614 pearl
WA walnut veneer	CE... César	KEHU... Hulk (Kent)	CR... Credo	LE2354 sienna
	CO... Comeback	LALO... Lobo	EN... Encircle	LE2691 dark brown
	EX... Extrema AU (+)	ME... Meld	SH... Shake	LE8246 mustard
	MLF... Main Line Flax	MR... Merit	TP... Topia	
	RN... Renew	RE... Remix 3		
		RW... Re-wool	Fabric cat. 5	
			HA... Hallingdal 65	
			CT... Steelcut 3	
			TR... Steelcut Trio 3	
			VI... Vidar 4	

... = add fabric color code



(+) = 4 colors available: 2250 black, 4550 light blue, 1550 petrol and 4450 mushroom

Example code: TAB2406HA166G = 1.305

TAB Chair

4. TAB Chair visitor's chairs and bar stool - upholstered back

List prices

Base	Code	Fabric					Leather	
		Cat. 1	Cat. 2	Cat. 3	Cat. 4	Cat. 5		
4.1. Visitor's chair on sledge base on glides Stackable up till 6 chairs								
	Black lacquered plastic glides felt glides	TAB24 * G TAB24 * F	1.215	1.305	1.420	1.525	1.640	1.965
	Chrome plastic glides felt glides	TAB22 * G TAB22 * F	1.250	1.340	1.455	1.560	1.675	2.000
4.2. Visitor's chair on cantilever on glides (till end of stock)								
	Black lacquered plastic glides felt glides	TAB44 * G TAB44 * F	1.380	1.470	1.585	1.690	1.805	2.130
4.3. Bar stool on glides								
	Black lacquered plastic glides felt glides	TAB34 * G TAB34 * F	1.260	1.345	1.460	1.565	1.680	2.005
	Chrome plastic glides felt glides	TAB32 * G TAB32 * F	1.290	1.390	1.495	1.610	1.715	2.040

* FINISHES & CODES

Upholstery			
Fabric cat. 1	Fabric cat. 3	Fabric cat. 4	Leather
QUQU... Quest	BLBL... Blazer	ARAR... Arco	LELE1000 black
	KEATAT... Atom (Kent)	CACA... Canvas 2	LELE1171 warm grey
Fabric cat. 2	KECACA... Castle (Kent)	CLCL... Cleo	LELE1614 pearl
CECE... César	KEHUHU... Hulk (Kent)	CRCR... Credo	LELE2354 sienna
COCO... Comeback	LALOLO... Lobo	ENEN... Encircle	LELE2691 dark brown
EXEX... Extrema AU (+)	MEME... Meld	SHSH... Shake	LELE8246 mustard
MLFMLF... Main Line Flax	MRMR... Merit	TPTP... Topia	
RNRN... Renew	RERE... Remix 3		
	RWRW... Re-wool		
		Fabric cat. 5	
		HAHA... Hallingdal 65	
		CTCT... Steelcut 3	
		TRTR... Steelcut Trio 3	
		VIVI... Vidar 4	

... = add fabric color code



(+) = 4 colors available: 2250 black, 4550 light blue, 1550 petrol and 4450 mushroom

Example code: TAB24HAHA166G = 1.640

TAB Lounge Chair & Ottoman

5. Tab Lounge Chair and Ottoman

List prices

	Base	Code	Fabric					Leather
			Cat. 1	Cat. 2	Cat. 3	Cat. 4	Cat. 5	
With auto-return. On felt glides.								
5.1. Lounge chair with auto-return								
	Black lacquered	TABLONA04 *	2.970	3.060	3.195	3.335	3.475	4.230
	Polished aluminium	TABLONACH *	3.065	3.155	3.295	3.435	3.570	4.330
5.2. Ottoman								
	Black lacquered	TABLOOT04 *	1.615	1.680	1.755	1.820	1.895	2.030
	Polished aluminium	TABLOOTCH *	1.715	1.780	1.855	1.920	1.990	2.130

* FINISHES & CODES

1) Shell	2) Upholstery			
WA walnut veneer	Fabric cat. 1	Fabric cat. 3	Fabric cat. 4	Leather
OA oak veneer	QU... Quest	BL... Blazer	AR... Arco	LE1000 black
EE black lacquered oak veneer (veneer horizontally applied)	Fabric cat. 2	KEAT... Atom (Kent)	CA... Canvas 2	LE1171 warm grey
	CE... César	KECA... Castle (Kent)	CL... Cleo	LE1614 pearl
	CO... Comeback	KEHU... Hulk (Kent)	CR... Credo	LE2354 sienna
	EX... Extrema AU (+)	LALO... Lobo	EN... Encircle	LE2691 dark brown
	MLF... Main Line Flax	ME... Meld	SH... Shake	LE8246 mustard
	RN... Renew	MR... Merit	TP... Topia	
		RW... Re-wool		
			Fabric cat. 5	
			HA... Hallingdal 65	
			CT... Steelcut 3	
			TR... Steelcut Trio 3	
			VI... Vidar 4	

... = add fabric color code

(+) = 4 colors available: 2250 black, 4550 light blue, 1550 petrol and 4450 mushroom

Example code: TABLONA04WACO45 = 3.060

TAB

6. Colors and materials



TAB CHAIR SHELL

	Lily white NCS S 0502-Y lacquered
	Coffee bean/black NCS S 8500 N lacquered
	Grey-green NCS S 6500-G80Y lacquered
	Red NCS S 1085-Y90R lacquered
	Walnut veneer
	Oak veneer



TAB MESH UPHOLSTERY

	10 Black
	12 Black & white
	31 Caramel
	70 Deep sea blue
Material:	Mix Synthetic
Composition:	720 g/rm
Weight:	600 g/m ²
Abrasion resistance:	300.000 Martindale
Flammability:	D - DIN EN 1021-1 (cigarette test) D - DIN EN 1021-2 (butane flame test)
Fastness to light:	D - DIN EN ISO 105-B02: 2014 6
Fastness to rubbing:	D - DIN EN ISO 105-X12: 2016 4-5
Fastness to perspiration:	D - DIN EN ISO 105-E04: 2013 4-5
Fastness to dry cleaning:	D - DIN EN ISO 105-D01: 2010 4-5

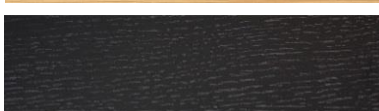
TAB LOUNGE CHAIR SHELL veneer horizontally applied

	Walnut veneer
	Oak veneer
	Black lacquered oak veneer

BASE

	Black
	Chrome (sledge and bar stool)
	Polished aluminium (TAB Mesh 4-star and TAB Lounge chair)

VVD Chair & VVD Slim Chair

by Vincent Van Duysen



VVD Chair

by Vincent Van Duysen

VVD Chair is a refined chair designed by belgian architect Vincent Van Duysen and characterized by pure lines, specific profile, remarkable ergonomic qualities and the use of innovative materials.

VVD Chair is made out of a metal frame and ilira stretch material, which provides a lot of comfort and makes it possible to have an exceptionally fine and light shape.

All desk chairs in the collection always have black glazed porcelain handles on the mechanism from 1st January 2020.

VVD Chair on castors is available with black pvc castors or castors with stainless steel cover. Hard castors for carpet floors or soft castors for hard floors or wooden floors.

New armrest design as from January 2023.

VVD CHAIR

Desk chair with high back

With or without arm rests
On 5-star base
Base diam.: 26.89"
Seat height range:
18.31" - 21.26"
Mechanism handles in
black porcelain

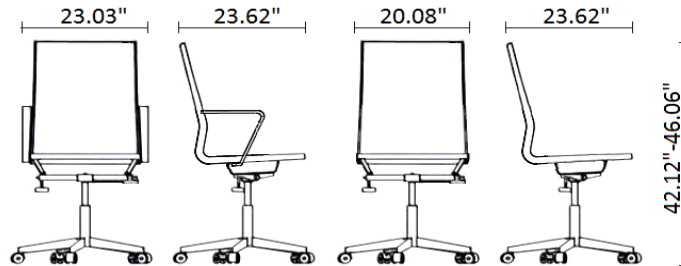

Desk chair with middle high back

With or without arm rests
On 5-star base
Base diam.: 26.89"
Seat height range:
18.31" - 21.26"
Mechanism handles in
black porcelain

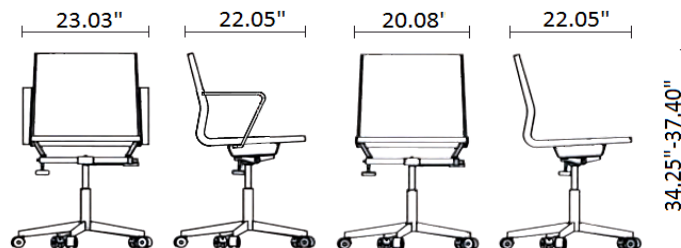

Visitor's chair on 5-star base

Middle high back
With or without arm rests
5-star base on castors
Base diam.: 26.89"
Seat height: 18.5"

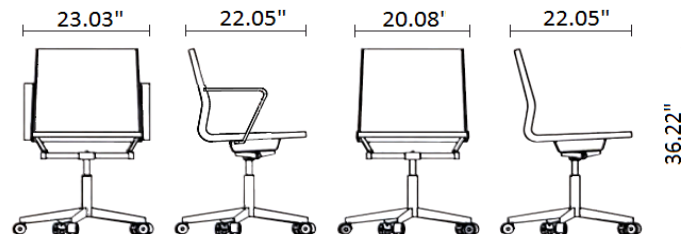

Visitor's chair on 4-star base

Middle high back
With or without arm rests
4-star base on glides
Base diam.: 26.89"
Seat height: 18.5"

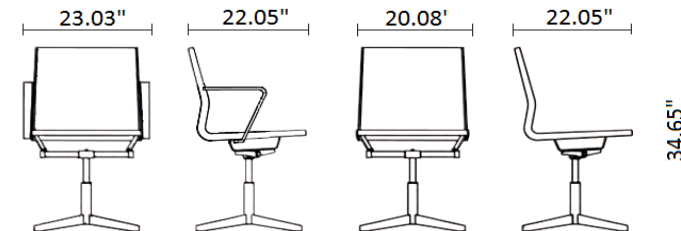

Lounge chair

Middle high back
With or without arm rests
4-star base on glides
Base diam.: 26.89"
Seat height: 17.32"

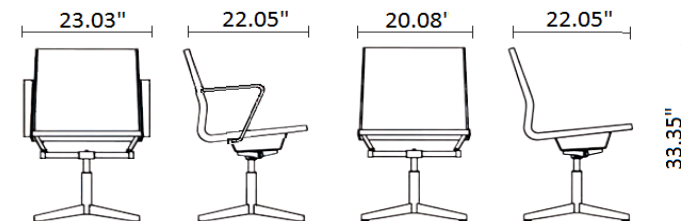

VVD Chair

by Vincent Van Duysen

FUNCTIONS DESK CHAIR



1. Adjustment to body weight
2. Steel tilt mechanism based on a torsion bar
3. Seat height adjustment
4. Fixation of the tilt mechanism





CODE COMPOSITION

VVD4 ZW 04 ZW L1 Z B
Chair type Base finish Arm rests finish (00 when no arm rests) Side profiles finish Upholstery code Type of castors/glides Black pvc castors

VVD Chair

1. Desk chair

List prices

	Arm rests	Side profiles	Base	Code							Fabric				Leather
					type	base	arms	prof.	uph.	castors		Cat. 2	Cat. 3	Cat. 4	
1.1. High back															
1.1.1. Without arm rests															
	no	black	black brushed	VVD4	ZW	00	ZW	***	+	++	3.545	3.610	3.670	3.775	3.965
				VVD4	RV	00	ZW	***	+	++	4.140	4.210	4.275	4.380	4.570
	no	veneer	black brushed	VVD4	ZW	00	**	***	+	++	3.650	3.715	3.775	3.885	4.075
				VVD4	RV	00	**	***	+	++	4.255	4.320	4.380	4.485	4.675
	1.1.2. With arm rests														
		aluminium	black	black brushed	VVD4	ZW	*	ZW	***	+	++	4.385	4.450	4.510	4.620
VVD4					RV	*	ZW	***	+	++	4.985	5.055	5.110	5.215	5.405
aluminium		veneer	black brushed	VVD4	ZW	*	**	***	+	++	4.500	4.570	4.625	4.730	4.920
				VVD4	RV	*	**	***	+	++	5.100	5.165	5.230	5.335	5.525
1.2. Middle high back															
1.2.1. Without arm rests															
	no	black	black brushed	VVD1	ZW	00	ZW	***	+	++	3.145	3.210	3.270	3.375	3.565
				VVD1	RV	00	ZW	***	+	++	3.745	3.810	3.875	3.980	4.170
	no	veneer	black brushed	VVD1	ZW	00	**	***	+	++	3.250	3.315	3.375	3.485	3.675
				VVD1	RV	00	**	***	+	++	3.855	3.920	3.980	4.085	4.275
	1.2.2. With arm rests														
		aluminium	black	black brushed	VVD1	ZW	*	ZW	***	+	++	3.985	4.050	4.110	4.220
VVD1					RV	*	ZW	***	+	++	4.585	4.655	4.710	4.815	5.005
aluminium		veneer	black brushed	VVD1	ZW	*	**	***	+	++	4.105	4.170	4.225	4.330	4.520
				VVD1	RV	*	**	***	+	++	4.700	4.765	4.830	4.935	5.125

FINISHES & CODES

* Aluminium arm rests	** Veneer	*** Upholstery		+ Type of castors
TI titanium anodised	EK oak	Fabric cat. 2	Fabric cat. 4	H hard castors for carpet
04 black anodised	NO walnut	CE... César	AR... Arco	Z soft castors for hard floors
	PA padouk	CO... Comeback	CA... Canvas 2	or wooden floors
	WE wenge	MLF... Main Line Flax	CL... Cleo	
	EE black lacquered oak		CR... Credo	++ only for black pvc castors
		Fabric cat. 3	TP... Topia	B add 'B' to the code
		BL... Blazer		(code without B = stainless steel covered castors)
		ME... Meld	Fabric cat. 5	
		MR... Merit	HA... Hallingdal 65	
		RE... Remix 3	CT... Steelcut 3	
			TR... Steelcut Trio 3	
			VI... Vidar 4	
			Leather	
			L1 black	





... = add fabric color code

Code example: VVD4ZW04ZW11ZB = 4.805

VVD Chair

2. Visitor's chair

List prices

	Arm rests	Side profiles	Base	Code							Fabric				Leather			
						Cat. 2	Cat. 3	Cat. 4	Cat. 5									
2.1. 5-star base on castors						type		base	arms	prof.	uph.	castors						
2.1.1. Without arm rests												type	color					
	no	black	black	VVD2	ZW	00	ZW	***	+	++			3.125	3.180	3.230	3.325	3.545	
			brushed	VVD2	RV	00	ZW	***	+	++				3.725	3.780	3.835	3.920	4.140
	no	veneer	black	VVD2	ZW	00	**	***	+	++				3.230	3.290	3.345	3.430	3.650
			brushed	VVD2	RV	00	**	***	+	++				3.835	3.885	3.940	4.030	4.255
2.1.2. With arm rests																		
	aluminium	black	black	VVD2	ZW	*	ZW	***	+	++			3.970	4.030	4.085	4.175	4.400	
			brushed	VVD2	RV	*	ZW	***	+	++				4.575	4.625	4.680	4.770	4.995
	aluminium	veneer	black	VVD2	ZW	*	**	***	+	++				4.085	4.135	4.190	4.280	4.500
			brushed	VVD2	RV	*	**	***	+	++				4.680	4.740	4.790	4.875	5.100
2.2. 4-star base on glides						type		base	arms	prof.	uph.	glides						
2.2.1. Without arm rests																		
	no	black	black	VVD0	ZW	00	ZW	***	+++				2.990	3.050	3.100	3.185	3.415	
	no	veneer	black	VVD0	ZW	00	**	***	+++					3.100	3.155	3.205	3.295	3.520
2.2.2. With arm rests																		
	aluminium	black	black	VVD0	ZW	*	ZW	***	+++				3.840	3.895	3.945	4.035	4.260	
	aluminium	veneer	black	VVD0	ZW	*	**	***	+++					3.945	4.005	4.055	4.140	4.370

FINISHES & CODES

* Aluminium arm rests	** Veneer	*** Upholstery	+ Castors for 5-star base
TI titanium anodised	EK oak	Fabric cat. 2	H hard castors for carpet
04 black anodised	NO walnut	CE... César	Z soft castors for hard floors or wooden floors
	PA padouk	CO... Comeback	
	WE wenge	MLF... Main Line Flax	++ only for black pvc castors
	EE black lacquered oak	Fabric cat. 3	B add 'B' to the code
		BL... Blazer	(code without B = stainless steel covered castors)
		ME... Meld	
		MR... Merit	+++ Glides for 4-star base
		RE... Remix 3	G plastic glides for carpet and hard floors
		Fabric cat. 4	V felt glides for wooden floors
		AR... Arco	
		CA... Canvas 2	
		CL... Cleo	
		CR... Credo	
		TP... Topia	
		Fabric cat. 5	
		HA... Hallingdal 65	
		CT... Steelcut 3	
		TR... Steelcut Trio 3	
		VI... Vidar 4	
		Leather	
		L1 black	

... = add fabric color code

Code example: VVD2ZW00NOCT240HB = 3.430

VVD Chair

3. Lounge chair

List prices

	Arm rests	Side profiles	Base	Code				Fabric				Leather		
				type	base	arms	prof.	uph.	glides	Cat. 2	Cat. 3		Cat. 4	Cat. 5
Without arm rests														
	no	black	black	VVD3	ZW	00	ZW	***	+++	3.035	3.095	3.145	3.230	3.455
	no	veneer	black	VVD3	ZW	00	**	***	+++	3.145	3.200	3.250	3.345	3.565

FINISHES & CODES

* Aluminium arm rests		** Veneer		*** Upholstery		+++ Glides for 4-star base
TI	titanium anodised	EK	oak	Fabric cat. 2	Fabric cat. 4	G plastic glides for carpet and hard floors
04	black anodised	NO	walnut	CE... César	AR... Arco	V felt glides for wooden floors
		PA	padouk	CO... Comeback	CA... Canvas 2	
		WE	wenge	MLF... Main Line Flax	CL... Cleo	
		EE	black lacquered oak	Fabric cat. 3	CR... Credo	
				BL... Blazer	TP... Topia	
				ME... Meld	Fabric cat. 5	
				MR... Merit	HA... Hallingdal 65	
				RE... Remix 3	CT... Steelcut 3	
					TR... Steelcut Trio 3	
					VI... Vidar 4	
					Leather	
					L1	black

... = add fabric color code

Code example: VVD3ZW00ZWMLF02G = 3.035

VVD Chair

4. Colors and materials

BASE



Brushed, nickel plated steel, matt transparent varnished (5-star base only)



Black lacquered ral 9005

ARM RESTS



Solid aluminium titanium anodized



Solid aluminium black anodized

SIDE PROFILES



Black lacquered (side profiles only)

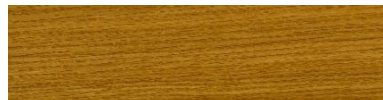

European oak veneer



Walnut veneer



Padouk veneer



Wenge veneer



Black lacquered European oak veneer

VVD Slim Chair

by Vincent Van Duysen

VVD Slim Chair is a separate collection within the VVD Chair range, with an even slimmer shell.
The seat and back of VVD Slim Chair are upholstered all around, with or without seat stitching.

Desk chair

on 5-star base
Base diam.: 26.89"
Seat height range:
18.31" - 20.87"
Mechanism handles in
black porcelain

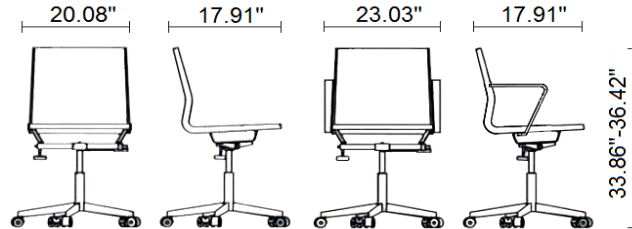

Visitor's chair on 5-star base

5-star base on castors
Base diam.: 26.89"
Seat height: 18.50"

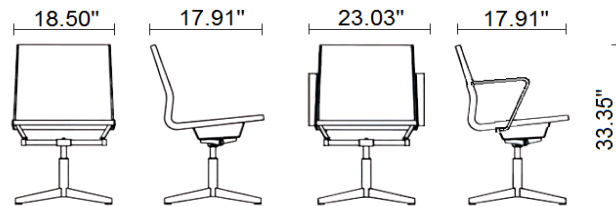

Visitor's chair on 4-star base

4-star base on glides
Base diam.: 26.89"
Seat height: 18.50"

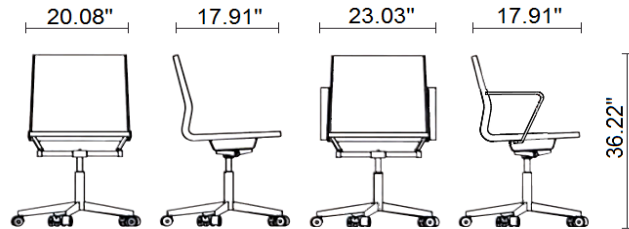

Lounge chair

4-star base on glides
Base diam.: 26.89"
Seat height: 17.32"

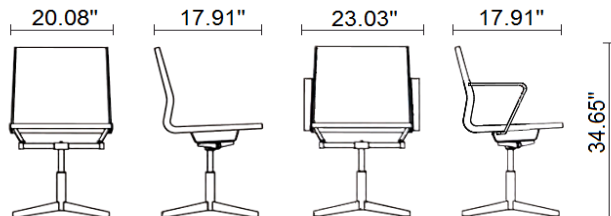

SEAT STITCHING

VVD Slim Chair
with seat stitching



VVD Slim Chair
without seat stitching



FUNCTIONS DESK CHAIR



1. Adjustment to body weight
2. Steel tilt mechanism based on a torsion bar
3. Seat height adjustment
4. Fixation of the tilt mechanism





CODE COMPOSITION

VVDS1 M 04 00 L1 ZB

Chair type
With/without seat stitching
Base finish
Without arm rests
Upholstery code
Type of castors/glides

VVD Slim Chair

1. On 5-star base

	Arm rests	Base	Code	Fabric				Leather
				Cat. 2	Cat. 3	Cat. 4	Cat. 5	(+)
1.1. Desk chair without arm rests			type stitch base arms uph. cast.					
	no	black	VVDS1 * 04 00 *** +	2.440	2.490	2.545	2.635	2.860
1.2. Desk chair with arm rests			type stitch base arms uph. cast.					
	aluminium	black	VVDS1 * 04 ** *** +	3.275	3.330	3.380	3.480	3.695
1.3. Visitor's chair without arm rests			type stitch base arms uph. cast.					
	no	black	VVDS2 * 04 00 *** +	2.420	2.470	2.525	2.615	2.840
1.4. Visitor's chair with arm rests			type stitch base arms uph. cast.					
	aluminium	black	VVDS2 * 04 ** *** +	3.260	3.310	3.365	3.455	3.675

FINISHES & CODES

* Seat stitching in tone on tone color

Z without stitching

M with stitching

Upcharge for seat stitching:

+ 220

** Aluminium arm rests

TI titanium anodised

04 black anodised

*** Upholstery

Fabric cat. 2

CE... César

CO... Comeback

MLF... Main Line Flax

Fabric cat. 3

ME... Meld

MR... Merit

Fabric cat. 4

AR... Arco

CL... Cleo

CR... Credo

SH... Shake

TP... Topia

Fabric cat. 5

HA... Hallingdal 65

CT... Steelcut 3

TR... Steelcut Trio 3

VI... Vidar 4

Leather

L1 black

+ Type of black pvc castors

HB hard castors for carpet

ZB soft castors for hard floors or wooden floors



... = add fabric color code

(+) Leather chairs are always with seat stitching

Code example: VVDS1M0400CRSNOZB = 2.765

VVD Slim Chair

2. On 4-star base

	Arm rests	Base	Code	Fabric				Leather
				Cat. 2	Cat. 3	Cat. 4	Cat. 5	(+)
2.1. Visitor's chair without arm rests On felt glides			type stitch base arms uph. glides					
	no	black	VVDS0 * 04 00 *** V	2.280	2.340	2.395	2.480	2.710
2.2. Visitor's chair with arm rests On felt glides			type stitch base arms uph. glides					
		black	VVDS0 * 04 ** *** V	3.120	3.180	3.230	3.315	3.545
2.3. Lounge chair without arm rests On felt glides			type stitch base arms uph. glides					
		black	VVDS3 * 04 ** *** V	2.330	2.385	2.440	2.525	2.745

FINISHES & CODES

* Seat stitching in tone on tone color

Z	without stitching
M	with stitching
	Upcharge for seat stitching: + 220

** Aluminium arm rests

TI	titanium anodised
04	black anodised

*** Upholstery

Fabric cat. 2	Fabric cat. 4
CE... César	AR... Arco
CO... Comeback	CL... Cleo
MLF... Main Line Flax	CR... Credo
	SH... Shake
	TP... Topia
Fabric cat. 3	Fabric cat. 5
ME... Meld	HA... Hallingdal 65
MR... Merit	CT... Steelcut 3
	TR... Steelcut Trio 3
	VI... Vidar 4

Leather

L1 black

... = add fabric color code

(+) Leather chairs are always with seat stitching

Code example: VVDS0Z0400CO45V = 2.280

VVD Slim Chair

3. Colors and materials

BASE



Black lacquered
ral 9005

ARM RESTS



Solid aluminium
titanium anodised



Solid aluminium
black anodised

VVD Bistro Chair

by Vincent Van Duysen



VVD Bistro Chair

by Vincent Van Duysen

The VVD Bistro Chair is a continuation of the successful VVD Chair and VVD Slim Chair design by Vincent Van Duysen. All chairs have the ergonomic curve in the back in common. In line with current and future movements the shell of VVD Bistro Chair is made from recycled polypropylene. Tapping into its own waste stream, creating a largely circular production process, it comes in durable and ecological finish options for base and upholstery. Monocolor chairs have the base and the polypropylene seat in the same color.

DIMENSIONS

4 steel legs - stackable till 10 pieces

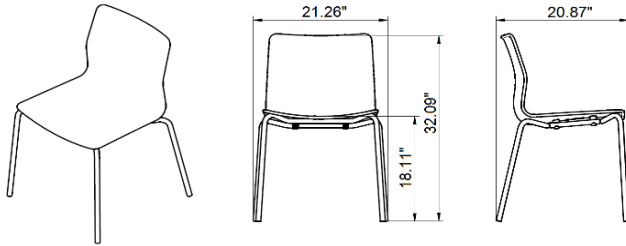

Steel sledge base - stackable till 10 pieces

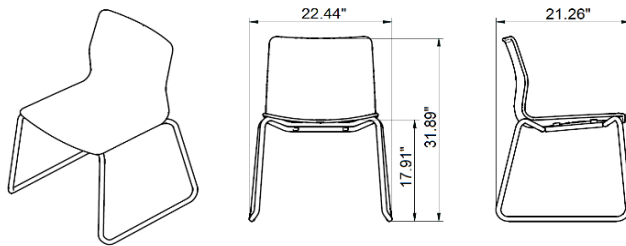

With armrests, 4 steel legs - stackable till 10 pieces

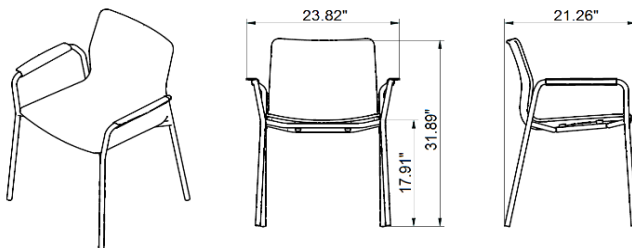

Unupholstered shell with polypropylene arm rest pads in the same color.

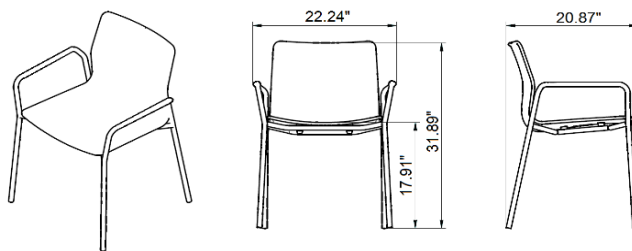

No arm rest pads with upholstered shell.

4 solid wooden legs - not stackable

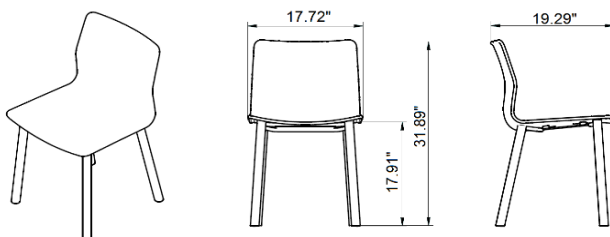

VVD Bistro Chair

by Vincent Van Duysen

Barstool - stackable till 10 pieces

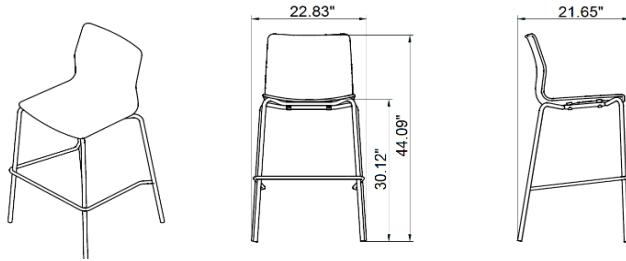

Barstool - height adjustable

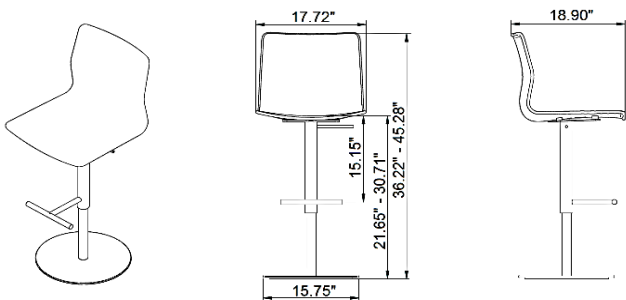

Desk chair on trestle 5-star base, swivel, on universal castors - height adjustable

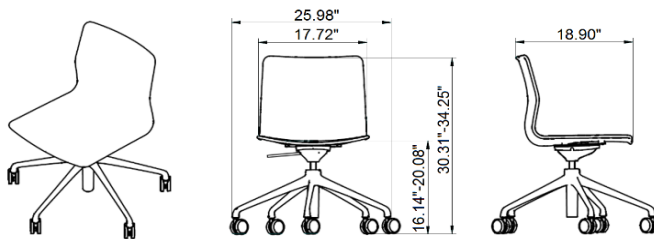

Visitor's chair on trestle 4-star base, swivel, on universal castors - fixed height

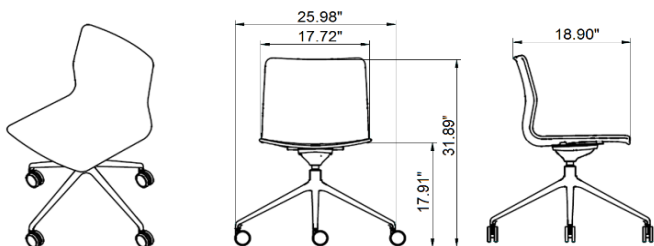

Visitor's chair on trestle 4-star base, swivel, on felt glides - fixed height

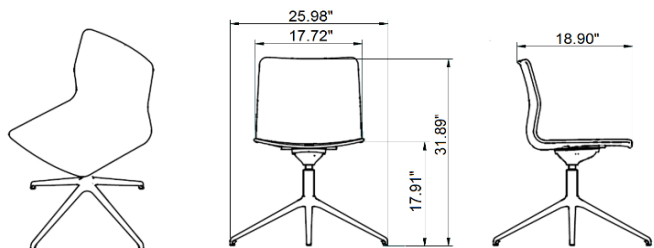

VVD Bistro Chair

1. Steel base

List prices

Finish	Code	Polyp.	Fabric						leather	
			Cat. 1	Cat. 2	Cat. 3	Cat. 4	Cat. 5	Cat. 6		
1.1. 4 steel legs w 21.16" x d 20.87" x h 32.09", seat height 18.11" Stackable till 10 pieces. Universal glides										
	Black base	VVDACH04 * G	385	1.060	1.150	1.250	1.355	1.455	2.220	2.220
	Monocolor midnight blue	VVDACHBLBLG	510							
	Monocolor grey-green	VVDACHGGGGG	510							
	Monocolor nude	VVDACHNUNUG	510							
	Monocolor white	VVDACH0101G	510							

1.2. Sledge base

w 22.44" x d 21.16" x h 31.89", seat height 17.91"
Stackable till 10 pieces



Black base, plastic glides	VVDASL04 * G	385	1.060	1.150	1.250	1.355	1.455	2.220	2.220
Black base, felt glides	VVDASL04 * F								
Monocolor midnight blue plastic glides	VVDASLBLBLG	510							
felt glides	VVDASLBLBLF								
Monocolor grey-green plastic glides	VVDASLGGGGG	510							
felt glides	VVDASLGGGGF								
Monocolor nude plastic glides	VVDASLNUNUG	510							
felt glides	VVDASLNUNUF								
Monocolor white plastic glides	VVDASL0101G	510							
felt glides	VVDASL0101F								

1.3. With armrests, 4 steel legs

w 22.24"/23.82" x d 20.47" x h 31.89", seat height 17.91"
Stackable till 10 pieces. Universal glides.

Unupholstered chairs have polypropylene armrest pads in the same color as the shell. Upholstered chairs do not have armrest pads.



Black base	VVDAAR04 * G	465	1.140	1.230	1.330	1.435	1.535	2.300	2.300
Monocolor midnight blue	VVDAARBLBLG	590							
Monocolor grey-green	VVDAARGGGGG	590							
Monocolor nude	VVDAARNUNUG	590							
Monocolor white	VVDAAR0101G	590							

* FINISHES & CODES

Polypropylene	1) Shell				2) Handle in saddle leather On upholstered shell only!
	Upholstery		Fabric cat. 5		
BL midnight blue	Fabric cat. 1	Fabric cat. 3	Fabric cat. 4	Fabric cat. 5	00 Without handle
GG grey-green	QU... Quest	BL... Blazer	AR... Arco	HA... Hallingdal 65	BR Chocolate brown
NU nude		KEAT... Atom (Kent)	CA... Canvas 2	CT... Steelcut 3	Upcharge for handle:
RO oxide red	Fabric cat. 2	KECA... Castle (Kent)	CL... Cleo	TR... Steelcut Trio 3	+ 145
01 white	CE... César	KEHU... Hulk (Kent)	CR... Credo	VI... Vidar 4	
	CO... Comeback	LALO... Lobo	EN... Encircle		
	EX... Extrema AU (+)	ME... Meld	SH... Shake	Fabric cat. 6	
	MLF... Main Line Flax	MR... Merit	TP... Topia	JUDCR Judith Crème	
	RN... Renew	RE... Remix 3			
		RW... Re-wool			
				Leather	
				LE49000 Black	
				LE42008 Dark Brown	
				LE43010 Forest Green	
				LE41004 Sand Grey	
				LE42006 Tobacco Brown	



Code example: VVDACH04BLG = 385

... = add fabric color code

(+) = 4 colors available: 2250 black, 421.65" light blue, 121.65" petrol and 4450 mushroom

VVD Bistro Chair

2. Wooden legs

List prices

Finish	Code	Polyp.	Fabric						leather	
			Cat. 1	Cat. 2	Cat. 3	Cat. 4	Cat. 5	Cat. 6		
2. 4 solid wooden legs w 18.11" x d 18.90" x h 31.89", seat height 17.91" Not stackable										
	Base natural ash									
	universal glides	VVDAWOAN * G	780	1.455	1.545	1.645	1.750	1.850	2.615	2.615
	without glides	VVDAWOAN * 0								
	Base black lacquered ash									
	universal glides	VVDAWOAB * G	780	1.455	1.545	1.645	1.750	1.850	2.615	2.615
	without glides	VVDAWOAB * 0								
	Base walnut stained ash									
	universal glides	VVDAWOAW * G	780	1.455	1.545	1.645	1.750	1.850	2.615	2.615
without glides	VVDAWOAW * 0									
Monocolor midnight blue										
universal glides	VVDAWOBLBLG	680								
no glides	VVDAWOBLBLO									
Monocolor grey-green										
universal glides	VVDAWOGGGGG	680								
no glides	VVDAWOGGGGO									
Monocolor nude										
universal glides	VVDAWONUNUG	680								
no glides	VVDAWONUNNU0									
Monocolor white										
universal glides	VVDAWO0101G	680								
no glides	VVDAWO01010									

Monocolor chairs have their base lacquered in the same color as the polypropylene shell

* FINISHES & CODES

Polypropylene	1) Shell				2) Handle in saddle leather On upholstered shell only!
	Upholstery		Upholstery		
BL midnight blue	Fabric cat. 1	Fabric cat. 3	Fabric cat. 4	Fabric cat. 5	00 Without handle BR Chocolate brown Upcharge for handle: + 145  LE49000 Black LE42008 Dark Brown LE43010 Forest Green LE41004 Sand Grey LE42006 Tobacco Brown
GG grey-green	QU... Quest	BL... Blazer	AR... Arco	HA... Hallingdal 65	
NU nude		KEAT... Atom (Kent)	CA... Canvas 2	CT... Steelcut 3	
RO oxide red	Fabric cat. 2	KECA... Castle (Kent)	CL... Cleo	TR... Steelcut Trio 3	
01 white	CE... César	KEHU... Hulk (Kent)	CR... Credo	VI... Vidar 4	
	CO... Comeback	LALO... Lobo	EN... Encircle		
	EX... Extrema AU (+)	ME... Meld	SH... Shake	Fabric cat. 6	
	MLF... Main Line Flax	MR... Merit	TP... Topia	JUDCR Judith Crème	
	RN... Renew	RE... Remix 3			
		RW... Re-wool			
				Leather	
				LE49000 Black	
				LE42008 Dark Brown	
				LE43010 Forest Green	
				LE41004 Sand Grey	
				LE42006 Tobacco Brown	

Code example: VVDAWOANMLF0200G = 1545



... = add fabric color code

(+) = 4 colors available: 2250 black, 421.65" light blue, 121.65" petrol and 4450 mushroom

VVD Bistro Chair

3. Bar stool

List prices

Base	Code	Polyp.	Fabric						leather	
			Cat. 1	Cat. 2	Cat. 3	Cat. 4	Cat. 5	Cat. 6		
3.1. Bar stool on 4 legs w 22.83" x d 21.65" x h 44.09", seat height 34.25" Stackable till 2 pieces. Universal glides.										
	Black	VVDABS04 * G	505	1.165	1.260	1.360	1.465	1.575	2.300	2.300
3.2. Height adjustable bar stool with gas lift w 17.72" x d 18.90" x h 36.22" - 45.28", seat height 21.65" - 30.71" Felt glides										
	Black	VVDABH04 *	1.095	1.755	1.850	1.950	2.055	2.165	2.890	2.890

* FINISHES & CODES

Polypropylene	1) Shell				2) Handle in saddle leather On upholstered shell only!
	Upholstery		Upholstery		
BL midnight blue	Fabric cat. 1	Fabric cat. 3	Fabric cat. 4	Fabric cat. 5	00 Without handle BR Chocolate brown Upcharge for handle: + 145 
GG grey-green	QU... Quest	BL... Blazer	AR... Arco	HA... Hallingdal 65	
NU nude		KEAT... Atom (Kent)	CA... Canvas 2	CT... Steelcut 3	
RO oxide red	Fabric cat. 2	KECA... Castle (Kent)	CL... Cleo	TR... Steelcut Trio 3	
01 white	CE... César	KEHU... Hulk (Kent)	CR... Credo	VI... Vidar 4	
	CO... Comeback	LALO... Lobo	EN... Encircle		
	EX... Extrema AU (+)	ME... Meld	SH... Shake	Fabric cat. 6	
	MLF... Main Line Flax	MR... Merit	TP... Topia	JUDCR Judith Crème	
	RN... Renew	RE... Remix 3			
		RW... Re-wool			
				Leather	
				LE49000 Black	
				LE42008 Dark Brown	
				LE43010 Forest Green	
				LE41004 Sand Grey	
				LE42006 Tobacco Brown	

Code example: VVDABS0401G = 505



... = add fabric color code

(+) = 4 colors available: 2250 black, 421.65" light blue, 121.65" petrol and 4450 mushroom

VVD Bistro Chair

4. Trestle star base

List prices

Base	Code	Polyp.	Fabric						leather
			Cat. 1	Cat. 2	Cat. 3	Cat. 4	Cat. 5	Cat. 6	
2.1. Desk chair on trestle 5-star swivel base w 25.98" x d 18.90" x h 30.31"-34.25", seat height 16.14"-20.08" Height adjustable. Universal castors diam. 2.56"									
 Black	VVDADC04 *	815	1.470	1.560	1.655	1.755	1.860	2.585	2.585
2.2. Visitor's chair on trestle 4-star swivel base w 25.98" x d 18.90" x h 31.89", seat height 17.91" Fixed height. Universal castors diam. 2.56"									
 Black	VVDAVC04 * C	795	1.445	1.535	1.630	1.730	1.820	2.555	2.555
2.3. Visitor's chair on trestle 4-star swivel base w 25.98" x d 18.90" x h 31.89", seat height 17.91" Fixed height. On felt glides									
 Black	VVDAVC04 * F	795	1.445	1.535	1.630	1.730	1.820	2.555	2.555

* FINISHES & CODES

Polypropylene	1) Shell				2) Handle in saddle leather On upholstered shell only!
	Upholstery		Upholstery		
BL midnight blue	Fabric cat. 1	Fabric cat. 3	Fabric cat. 4	Fabric cat. 5	00 Without handle BR Chocolate brown Upcharge for handle: + 145 
GG grey-green	QU... Quest	BL... Blazer	AR... Arco	HA... Hallingdal 65	
NU nude		KEAT... Atom (Kent)	CA... Canvas 2	CT... Steelcut 3	
RO oxide red	Fabric cat. 2	KECA... Castle (Kent)	CL... Cleo	TR... Steelcut Trio 3	
01 white	CE... César	KEHU... Hulk (Kent)	CR... Credo	VI... Vidar 4	
	CO... Comeback	LALO... Lobo	EN... Encircle		
	EX... Extrema AU (+)	ME... Meld	SH... Shake	Fabric cat. 6	
	MLF... Main Line Flax	MR... Merit	TP... Topia	JUDCR Judith Crème	
	RN... Renew	RE... Remix 3			
		RW... Re-wool			
				Leather	
				LE49000 Black	
				LE42008 Dark Brown	
				LE43010 Forest Green	
				LE41004 Sand Grey	
				LE42006 Tobacco Brown	

Code example: VVDAVC04MLF0200C = 1.535

... = add fabric color code

(+) = 4 colors available: 2250 black, 421.65" light blue, 121.65" petrol and 4450 mushroom

VVD Bistro Chair

5. Accessories

List prices

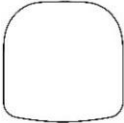
Base	Code	Fabric						leather
		Cat. 1	Cat. 2	Cat. 3	Cat. 4	Cat. 5	Cat. 6	
4.1. Cushion w 14.96" x d 15.16"								
	VVDACUSH *	175	190	215	240	245	490	490

4.2. Trolley for up to 12 unupholstered VVD Bistro chairs
w 23.23" x d 33.46"
in black lacquered metal
Dynamic load capacity 219 daN (decanewton)
Static load capacity 438 daN (decanewton)
Weight : 16 kg

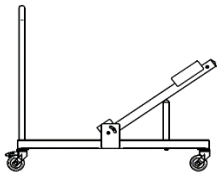

VVDATROL04 925

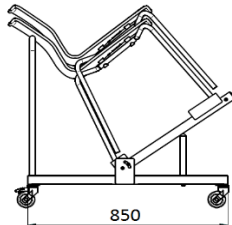
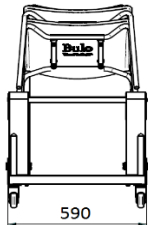

* FINISHES & CODES

Upholstery			
Fabric cat. 1	Fabric cat. 3	Fabric cat. 4	Fabric cat. 5
QU... Quest	BL... Blazer	AR... Arco	HA... Hallingdal 65
	KEAT... Atom (Kent)	CA... Canvas 2	CT... Steelcut 3
Fabric cat. 2	KECA... Castle (Kent)	CL... Cleo	TR... Steelcut Trio 3
CE... César	KEHU... Hulk (Kent)	CR... Credo	VI... Vidar 4
CO... Comeback	LALO... Lobo	EN... Encircle	
EX... Extrema AU (+)	ME... Meld	SH... Shake	Fabric cat. 6
MLF... Main Line Flax	MR... Merit	TP... Topia	JUDCR Judith Crème
RN... Renew	RE... Remix 3		
	RW... Re-wool		Leather
			LE49000 Black
			LE42008 Dark Brown
			LE43010 Forest Green
			LE41004 Sand Grey
			LE42006 Tobacco Brown

Code example: VVDACUSHCO45 = 190

... = add fabric color code

(+) = 4 colors available: 2250 black, 421.65" light blue, 121.65" petrol and 4450 mushroom

VVD Bistro Chair

6. Colors and materials

BASE



Solid ash wood
black lacquered



Solid ash wood
natural varnished

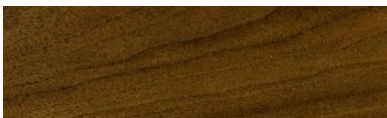

Solid ash wood
walnut color stained



Black lacquered
steel - Ral 9005

POLYPROPYLENE SHELL

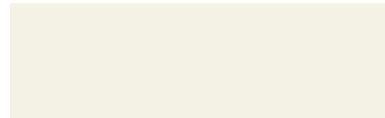

White
Ral 9016



Nude
NCS S2010-Y70R



Oxide red
Ral 3009



Grey-green
Ral 7003



Midnight blue
RAL 5008

MONOCOLOR BASE in steel or in solid beech wood

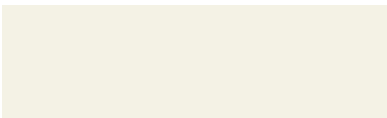

White
Ral 9016

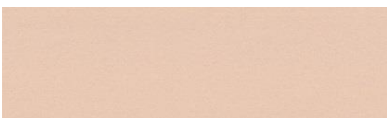

Nude
NCS S2010-Y70R



Grey-green
Ral 7003



Midnight blue
RAL 5008



The polypropylene used for the shell is licenced 'CSI plastic from byproduct' according to specific rules for the certification of recycled plastics and recycled plastic products (Doc. 002/13)

VVD Bistro table

by Vincent Van Duysen



VVD Bistro table

by Vincent Van Duysen

A seemingly simple but well engineered wooden leg brings us to the essence of a table. A top. A set of legs. Full stop. Simplicity and elegance are once again found central in the design language of this VVDA collaboration. This timeless product comes in durable finishes.

TECHNICAL DESCRIPTION

Dimensions

Round, diam. 33.46" x h 29.92", on 3 legs
Round, diam. 47.24" x h 29.92", on 4 legs
Oval, w 78.74" x d 39.37" x h 29.92", on 4 legs
Square, 35.43" x 35.43" x h 29.92", on 4 legs
Rectangular, 66.93" x d 35.43", on 4 legs

Leg finishes

Legs in lacquered solid beech wood, diam. 2.16". Lacquer colors: black, lily white, soft grey or grey-green

Top finishes

Lily white melamine with straight edges in matching 0.04"abs, 0.98" thick
Powdercoated mdf with rounded edges in colors lily white, soft grey or grey-green, 0.98" thick
Black Fenix hpl on black mdf with straight edges in black 0.04"abs, 0.98" thick
Veneer with straight veneer edges, 1.02" thick

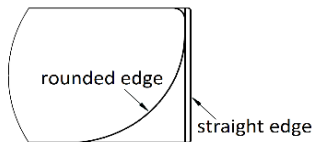

Grommet

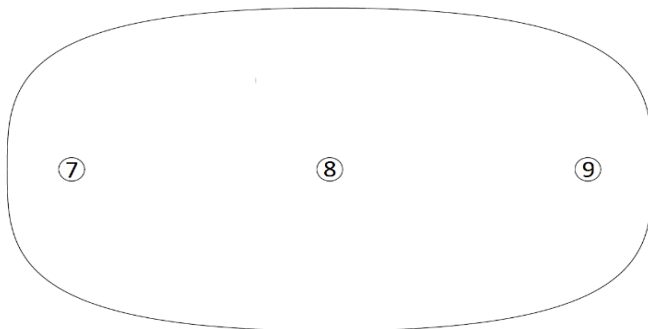

Only in oval table 78.74" x 39.37" and rectangular table 66.93" x 35.43".
Grommet positions left (7), central (8) or right (9)



VVD Bistro table

1. Tables

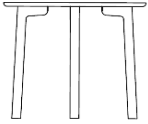
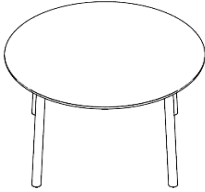
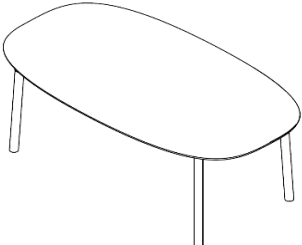
List prices

	Code	Top			
		Melamine (straight edge)	Powdercoat (rounded edge)	Fenix hpl (straight edge)	Veneer A (straight edge)
1. Round, diameter 33.46" x h 29.92" On 3 legs	VVDARO08 *	1.585	1.755	2.945	3.190
					
2. Round, diameter 47.24" x h 29.92" On 4 legs	VVDARO12 *	2.155	2.485	3.800	4.295
					
3. Oval shaped w 78.74" x d 39.37" h 29.92" On 4 legs	VVDAOV20 *	2.845	3.780	4.810	5.555
					

* FINISHES & CODES

1) Top, 0.98" thick

Melamine	Fenix hpl
01 lily white	F4 black

Powdercoated

GG grey-green	Veneer A
SG soft grey	ES ash
LW lily white	NN walnut
	EK European oak

2) Legs in solid wood

04 black lacquered beech
GG grey-green lacquered beech
SG soft grey lacquered beech
01 lily white lacquered beech

3) Grommet cutout in oval table

00 without grommet
G7 round, diam. 3.15", left
G8 round, diam. 3.15", central
G9 round, diam. 3.15", right
Upcharge per grommet cutout: + 83
Price grommet, see price list Electrification

Code example: VVDARO08GGGG00 = 1755

VVD Bistro table

Tables

List prices

	Code	Top			
		Melamine (straight edge)	Powdercoat (rounded edge)	Fenix hpl (straight edge)	Veneer A (straight edge)
4. Square, 35.43" x 35.43" x h 29.92" On 4 legs	VVDA0909 *	2.155	2.485	3.800	4.295

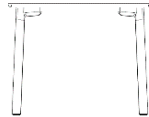
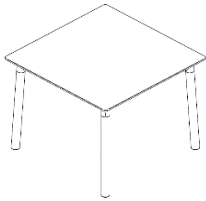

5. Rectangular, 66.93" x 35.43" x h 29.92"
On 4 legs

VVDA1709 *

2.845

3.780

4.810

5.555

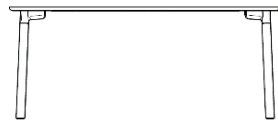
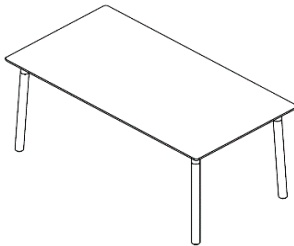

* FINISHES & CODES

1) Top, 0.98" thick

Melamine	Fenix hpl
01 lily white	F4 black

Powdercoated	Veneer A
GG grey-green	ES ash
SG soft grey	NN walnut
LW lily white	EK European oak

2) Legs in solid wood

04 black lacquered beech
GG grey-green lacquered beech
SG soft grey lacquered beech
01 lily white lacquered beech

3) Grommet cutout in rectangular table

00 without grommet
 G7 round, diam. 3.15", left
 G8 round, diam. 3.15", central
 G9 round, diam. 3.15", right
 Upcharge per grommet cutout: + 83
 Price grommet, see price list Electrification

Code example: VVDA0909GGGG00 = 2485

VVD Bistro table

2. Colors and materials

TOPS WITH STRAIGHT EDGE

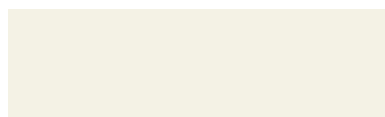

Melamine lily white



Fenix hpl black 0720



Natural ash veneer

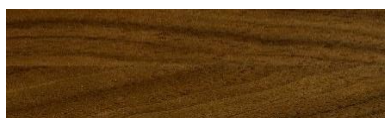

Natural walnut veneer

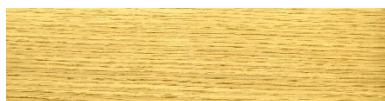

Natural European oak veneer

LACQUERED SOLID BEECH WOOD LEGS



Soft grey
NCS S 2502-Y



Grey-green
Ral 7003

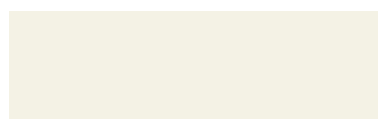

Lily white
Ral 9010



Black
Ral 9005

POWDERCOATED TOPS WITH ROUNDED EDGE



Grey-green
Ral 7003



Soft grey
NCS S 2502-Y

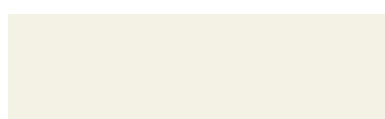

Lily white
Ral 9010

DAN

by BuloDesign



DAN

by BuloDesign

Work isn't constrained anymore by space, time or place, it just happens. DAN thrives in this shift towards more informal, flexible workstations and is developed with the sole purpose to create multifunctional and enjoyable working environments. DAN is in essence a modular collection. The construction is based on traditional Japanese joinery. It exists out of solid ash wood ladders and beams, and aluminium connecting parts. The name DAN, meaning 'level' in Japanese martial arts, refers to the ladder system. DAN is an environmentally friendly collection. The structure is made out of CO2 neutral, FSC certified solid ash wood from European origin. The tops and shelves are CO2 neutral. They are made out of laminated FSC certified chipboard. The FSC certified veneer is from European origin. The connectors are made out of recycled aluminium which reduces the CO2 emission with 80% compared to new aluminium.

BENCHES

Create benches with a start module and an end module. Add one or more connecting modules between the start module and the end module for longer benches.

Example: a bench for 6 persons = 1 start module + 1 connecting module + 1 end module



STABILITY PANELS

The finish of the stability panels is always in 0.71" thick black melamine

GROMMET POSITIONS

To ensure the correct cutout is made in the top, the type of grommet and its position must be indicated with the DAN table. The grommet itself has to be ordered separately, see price list Electrification. The below views are top views and seen from the user's side.

DAN single desk

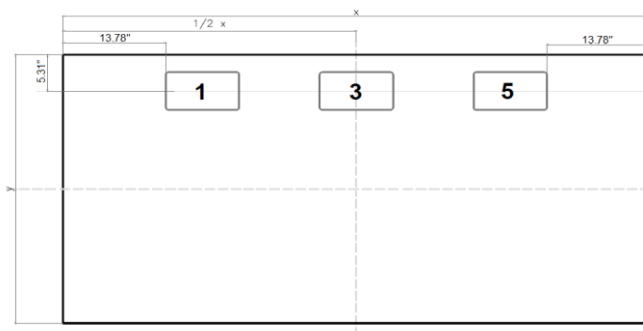

Grommet	Position 1, 3, 5	Position 7, 8, 9
Diam. 2.36"	✓	✓
Diam. 3.15"	✓	✓
Go	✓	✓
Hub E3		✓
Hub EL		✓
Normal	✓	✓
Point	✓	✓
Style (*)	✓	✓
Top Access	✓	✓
XXL	✓	✓

(*) 'Style' grommets require 8.27" between 2 opposite cutouts

DAN bench/meeting table

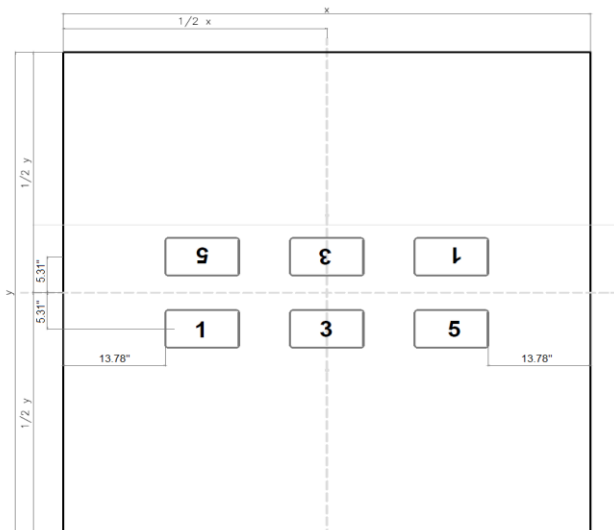
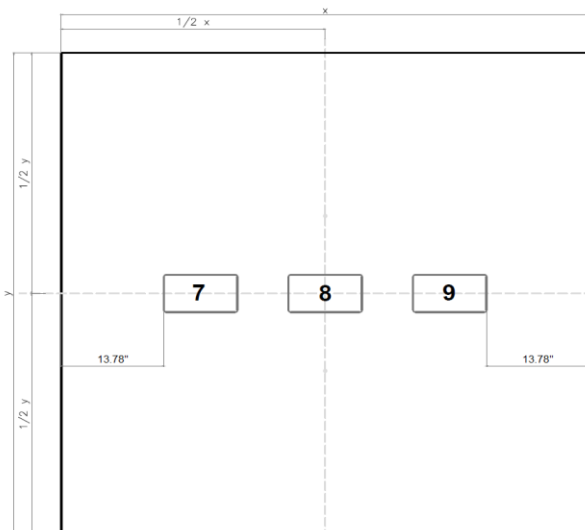

For benches/meeting tables existing out of modules, each module will have the same grommet cutout on the same position.



Double positions 1, 3 and 5 are possible as from a 62.99" deep table. The 'Style' grommet requires 20.39" between 2 opposite cutouts.

DAN

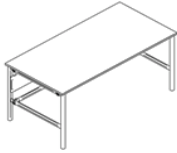
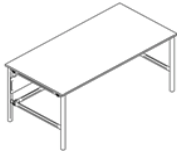
1. DAN desk, h.29.13"

		Code	Melamine	List prices Fenix
1.1. Individual	31.50" deep			
	w 39.37" x d 31.50"	DD0S1008 *	1.660	2.125
	w 47.24" x d 31.50"	DD0S1208 *	1.685	2.275
	w 55.12" x d 31.50"	DD0S1408 *	1.705	2.415
	w 62.99" x d 31.50"	DD0S1608 *	1.730	2.550
	w 70.87" x d 31.50"	DD0S1808 *	1.750	2.690
	w 78.74" x d 31.50" ***	DD0S2008 *	1.765	2.825
	w 86.61" x d 31.50" ***	DD0S2208 *	1.785	2.965
	35.43" deep **			
	w 39.37" x d 35.43"	DD0S1009 *	1.680	2.205
	w 47.24" x d 35.43"	DD0S1209 *	1.705	2.355
	w 55.12" x d 35.43"	DD0S1409 *	1.725	2.530
	w 62.99" x d 35.43"	DD0S1609 *	1.750	2.690
	w 70.87" x d 35.43"	DD0S1809 *	1.765	2.840
	w 78.74" x d 35.43" ***	DD0S2009 *	1.790	2.995
	w 86.61" x d 35.43" ***	DD0S2209 *	1.810	3.145
1.2. Double	62.99" deep			
	w 39.37" x d 62.99"	DD0S1016 *	3.410	-
	w 47.24" x d 62.99"	DD0S1216 *	3.465	-
	w 55.12" x d 62.99"	DD0S1416 *	3.500	-
	w 62.99" x d 62.99"	DD0S1616 *	3.565	-
	w 70.87" x d 62.99"	DD0S1816 *	3.600	-
	w 78.74" x d 62.99" ***	DD0S2016 *	3.680	-
	w 86.61" x d 62.99" ***	DD0S2216 *	3.705	-
	70.87" deep **			
	w 39.37" x d 70.87"	DD0S1018 *	3.435	-
	w 47.24" x d 70.87"	DD0S1218 *	3.495	-
	w 55.12" x d 70.87"	DD0S1418 *	3.545	-
	w 62.99" x d 70.87"	DD0S1618 *	3.600	-
	w 70.87" x d 70.87"	DD0S1818 *	3.640	-
	w 78.74" x d 70.87" ***	DD0S2018 *	3.690	-
	w 86.61" x d 70.87" ***	DD0S2218 *	3.720	-

* FINISHES & CODES

1) Top

0.71" melamine

18 lily white surface, black edging

0.71" hpl Fenix

(only for 31.50" and 35.43" deep tops)

F1 lily white

F2 beige Arizona

F3 grigio bromo

F4 black

F6 blu fes

F7 verde comodoro

2) Structure

AB solid ash, black lacquered

AN solid ash, natural

AW solid ash, walnut color stained

3) Connectors

B black

R red

4) Grommet

000 without grommets (skip 5)

E diam. 2.36" M Style 4

G diam. 3.15" N Style 5

H HUB (+) O Style 6

I Go (+) X XXL

J Normal Y Point

K Style 2 Z Top access

L Style 3

Upcharge per grommet cutout:
+ 73

Price grommet, see price list

Electrification

5) Grommet position

5a) Grommet 1

1 position 1

3 position 3

5 position 5

7 position 7

8 position 8

9 position 9

5b) Grommet 2

0 no 2nd grommet

1 position 1

3 position 3

5 position 5

7 position 7

8 position 8

9 position 9

Positions, see p.88

(+) only on 7, 8 or 9

Code example: DD0S161618ANRJ33 = 3.712

** a ladder is 30.83" deep. Desk tops 35.43" deep and 70.87" deep overhang the structure.

*** tops w 78.74" and w 86.61" on base w 70.87" x d 31.50"/62.99" overhang the structure equally on the left and right hand side.

DAN

2. DAN bench

Bench with double desks, h.29.13"

List prices
Melamine

DAN bench is formed by at least 1 start module + 1 end module. One or more connecting modules can be added.

2.1. 62.99" deep



Start module

w 39.37" x d 62.99"	DD0B1016*	3.525
w 47.24" x d 62.99"	DD0B1216 *	3.565
w 55.12" x d 62.99"	DD0B1416 *	3.600
w 62.99" x d 62.99"	DD0B1616 *	3.660
w 70.87" x d 62.99"	DD0B1816 *	3.705

Connecting module



w 37.80" x d 62.99"	DD0M1016*	2.795
w 45.67" x d 62.99"	DD0M1216 *	2.840
w 53.54" x d 62.99"	DD0M1416 *	2.875
w 61.42" x d 62.99"	DD0M1616 *	2.935
w 69.29" x d 62.99"	DD0M1816 *	2.975

End module



w 39.37" x d 62.99"	DD0E1016*	2.680
w 47.24" x d 62.99"	DD0E1216 *	2.715
w 55.12" x d 62.99"	DD0E1416 *	2.775
w 62.99" x d 62.99"	DD0E1616 *	2.820
w 70.87" x d 62.99"	DD0E1816 *	2.875

2.2. 70.87" deep **



Start module

w 39.37" x d 70.87"	DD0B1018 *	3.550
w 47.24" x d 70.87"	DD0B1218 *	3.595
w 55.12" x d 70.87"	DD0B1418 *	3.640
w 62.99" x d 70.87"	DD0B1618 *	3.705
w 70.87" x d 70.87"	DD0B1818 *	3.740

Connecting module



w 37.80" x d 70.87"	DD0M1018 *	2.825
w 45.67" x d 70.87"	DD0M1218 *	2.870
w 53.54" x d 70.87"	DD0M1418 *	2.905
w 61.42" x d 70.87"	DD0M1618 *	2.975
w 69.29" x d 70.87"	DD0M1818 *	3.010

End module

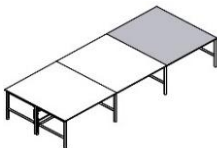

w 39.37" x d 70.87"	DD0E1018 *	2.710
w 47.24" x d 70.87"	DD0E1218 *	2.745
w 55.12" x d 70.87"	DD0E1418 *	2.820
w 62.99" x d 70.87"	DD0E1618 *	2.855
w 70.87" x d 70.87"	DD0E1818 *	2.910

* FINISHES & CODES

1) Top

0.71" melamine

18 lily white surface, black edging

2) Structure

AB solid ash, black lacquered

AN solid ash, natural

AW solid ash, walnut color stained

3) Connectors

B black

R red

4) Grommet

000 without grommets (skip 5)

E diam. 2.36" M Style 4

G diam. 3.15" N Style 5

H HUB (+) O Style 6

I Go (+) X XXL

J Normal Y Point

K Style 2 Z Top access

L Style 3

**Upcharge per grommet cutout:
+ 73**

Price grommet, see price list
Electrification

5) Grommet position

(same cutout in each top)

5a) Grommet 1

1 position 1

3 position 3

5 position 5

7 position 7

8 position 8

9 position 9

5b) Grommet 2

0 no 2nd grommet

1 position 1

3 position 3

5 position 5

7 position 7

8 position 8

9 position 9

Positions, see p.88

(+) only on 7, 8 or 9

Code example for a bench for 6 persons: DD0B161618ABBH80 + DD0M161618ABBH80 + DD0E161618ABBH80 = 9.635

** a ladder is 30.83" deep. A desk top 70.87" deep overhangs the structure.

DAN

3. DAN bench/meeting table, h.29.13"

	Code	Melamine	List prices Veneer
DAN benches/meeting tables come with centrally positioned, black lacquered crosses instead of stability panels			

3.1. Single top

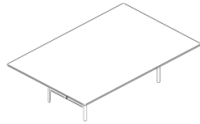

w 62.99" x d 62.99"	DM011616 *	3.565	6.315
w 70.87" x d 62.99"	DM011816 *	3.600	6.675
w 78.74" x d 62.99"	DM012016 *	3.690	7.075
w 86.61" x d 62.99"	DM012216 *	3.705	7.420
w 94.49" x d 62.99"	DM012416 *	3.840	7.870

3.2. Top in 2 parts



w 107.09" x d 62.99" = each top w 53.54" x d 62.99"	DM022716 *	6.880	11.725
w 122.83" x d 62.99" = each top w 61.42" x d 62.99"	DM023116 *	7.000	12.500
w 138.58" x d 62.99" = each top w 69.29" x d 62.99"	DM023516 *	7.080	13.220
w 154.33" x d 62.99" = each top w 77.17" x d 62.99"	DM023916*	7.245	14.670

3.3. Top in 3 parts

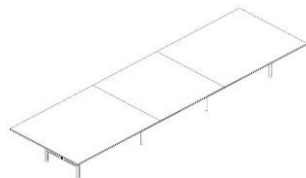

w 143.31" x d 62.99" outer tops each w 53.54" x d 62.99" central top w 36.22" x d 62.99"	DM033616	9.305	15.100
w 166.93" x d 62.99" outer tops each w 61.42" x d 62.99" central top w 44.09" x d 62.99"	DM034216	9.460	16.000
w 190.55" x d 62.99" outer tops each w 69.29" x d 62.99" central top w 51.97" x d 62.99"	DM034816	9.565	17.360
w 214.17" x d 62.99" outer tops each w 77.17" x d 62.99" central top w 59.84" x d 62.99"	DM035416	9.775	18.435

* FINISHES & CODES

1) Top

0.98" melamine
18 lily white surface, black edging

0.94" veneer

EK European oak
ES ash natural
EZ black lacquered ash
NN American walnut

2) Structure

AB solid ash, black lacquered
AN solid ash, natural
AW solid ash, walnut color stained

3) Connectors

B black
R red

4) Grommet

000 without grommets (skip 5)
E diam. 2.36" M Style 4
G diam. 3.15" N Style 5
H HUB (+) O Style 6
I Go (+) X XXL
J Normal Y Point
K Style 2 Z Top access
L Style 3

**Upcharge per grommet cutout:
+ 73**

Price grommet, see price list
Electrification

5) Grommet position

(same cutout in each top)

5a) Grommet 1
1 position 1
3 position 3
5 position 5
7 position 7
8 position 8
9 position 9

5b) Grommet 2
0 no 2nd grommet

1 position 1
3 position 3
5 position 5
7 position 7
8 position 8
9 position 9
Positions, see p.88
(+) only on 7, 8 or 9

Code example: DM012016ESANRH80 = 7.148

DAN

4. DAN ping pong table

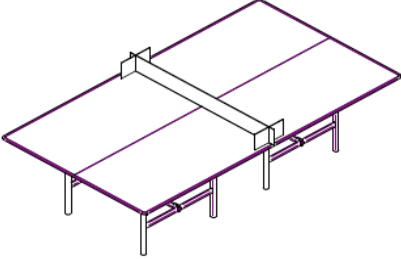
	Code	Melamine	List prices Veneer
Height 29.53" Top available in one piece or in two pieces (for easier access to the building). Not foldable.			
			
Top in melamine 0.98" thick Dims.: w 103.94" x d 60.04"	DP0D2715 *	4.485	
Top in veneer 1.06" thick Official olympic dimensions w 107.87" x d 60.04"	DP0D2715 *		9.015
Top in veneer 1.18" thick Official olympic dimensions w 107.87" x d 60.04"	DP0D2715 *		11.235

* FINISHES & CODES

1) Top

0.98" melamine
18 lily white surface, black edging

2) Structure

AB solid ash, black lacquered
AN solid ash, natural
AW solid ash, walnut color stained

3) Connectors

B black
R red

4) Ping pong net

0 without net

N with net

Upcharge for the net:
+ 610

5) Top in

1 one piece

2 two pieces

Veneer type A, on black mdf 0.98" thick, with chamfered edges, 1.06" thick (0.39" visible)

ES ash veneer (0.02")

EZ black lacquered ash veneer (0.02")

Veneer type A, on black mdf 0.98" thick, with chamfered edges, 1.18" thick (0.39" visible)

BL local beech veneer (0,09") with round corners and grooves that indicate the playfield

Code example: DP0D2715BLABB1 = 11.845







DAN



 = stability panel

5. DAN rack

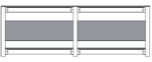
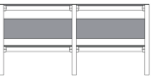
5.1. DAN storage rack - single sided use - 17.05" deep

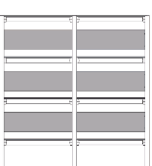
		Code	List prices
5.1.1. Single sided use, w 30.83"			
	h 19.69"	DR0S0805 *	620
	h 28.35"	DR0S0807 *	685
	h 44.88"	DR0S0811 *	1.015
	h 61.42"	DR0S0816 *	1.365
5.1.2. Single sided use, w 59.92"			
	h 19.69"	DR0S1505 *	940
	h 28.35"	DR0S1507 *	1.045
	h 44.88"	DR0S1511 *	1.495
	h 61.42"	DR0S1516 *	2.800

* FINISHES & CODES

1) Shelves

Shelves in melamine, 0.71" thick
18 lily white surface, black edging

2) Structure

AB solid ash, black lacquered
AN solid ash, natural
 AW solid ash, walnut color stained

3) Connectors

B black
R red

Code example: DR0S151618ANR = 2.800





DAN

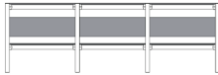

 = stability panel

DAN rack

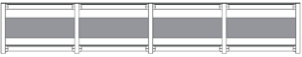
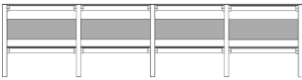
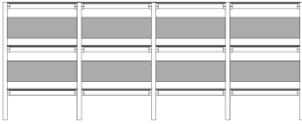
DAN storage rack - single sided use - 17.05" deep

		Code	List prices
5.1.3. Single sided use, w 89.02"			
	h 19.69"	DR0S2305 *	1.260
	h 28.35"	DR0S2307 *	1.405
	h 44.88"	DR0S2311 *	2.015
	h 61.42"	DR0S2316 *	2.820
5.1.4. Single sided use, w 118.11"			
	h 19.69"	DR0S3005 *	1.740
	h 28.35"	DR0S3007 *	1.910
	h 44.88"	DR0S3011 *	2.775
	h 61.42"	DR0S3016 *	5.195

* FINISHES & CODES

1) Shelves

Shelves in melamine, 0.71" thick
18 lily white surface, black edging

2) Structure

AB solid ash, black lacquered
AN solid ash, natural
 AW solid ash, walnut color stained

3) Connectors

B black
R red

Code example: DR0S300518ANR = 1.740

DAN



 = stability panel

DAN rack

5.2. DAN storage rack - double sided use

Code List prices

Double sided use, d 17.05" x h 61.42"



w 30.83"

DR0D0816 *

1.325



w 59.92"

DR0D1516 *

2.015



w 89.02"

DR0D2316 *

2.685



w 118.11"

DR0D3016 *

3.685

* FINISHES & CODES

1) Shelves

Shelves in melamine, 0.71" thick
18 lily white surface, black edging

2) Structure

AB solid ash, black lacquered
AN solid ash, natural
 AW solid ash, walnut color stained



3) Connectors

B black
R red

Code example: DR0D301618ANR = 3.685

DAN

6. Accessories

	Finish	Code	List prices
6.1. Height adjustment parts			
Set of 4 height adjustment feet to screw underneath the legs of 2 ladders. Possible height adjustments : 1,18" or 1.97"			
Set of 4 pcs, 1.18" high.	black	DAC LE3004	115
Set of 4 pcs, 1.97" high	natural ash wood	DAC LE50AN	115
	black	DAC LE5004	115
6.2. Cable net			
Cable net w.35.43"	grey	ELCCN09UN08	215
	black	ELCCN09UN04	215
6.3. Cable clamps			
 	Single cable clamp 4.13", grey	ELCKK02	NET PRICES 22
	Double cable clamp 8.27", black	ELCKK04	22

DAN

7. Colors and materials

LADDER AND SUPPORTING BEAM



Solid ash wood
black lacquered



Solid ash wood
natural varnished

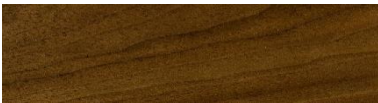

Solid ash wood
walnut color stained

TABLE TOP/SHELF SURFACE

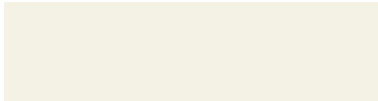

Lily white
melamine
(black edging)

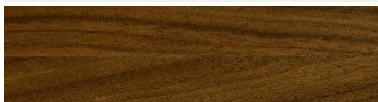

American walnut
veneer



Natural ash
veneer



Black lacquered
ash veneer



Natural ash veneer
on chamfered black mdf
for ping pong table



Black lacquered ash veneer
on chamfered black mdf
for ping pong table



Local beech veneer
on chamfered black mdf
for ping pong table

CONNECTOR



Aluminium
powdercoated
coral-red



Aluminium
powdercoated
black

FENIX HPL

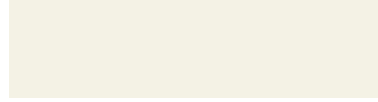

White 0029



Beige Arizona 0748



Grigio bromo 0724



Black 0720



Blu fes 0754



Verde comodoro 0750

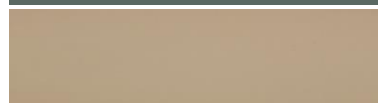

Beige luxor 0719



Rosso jaipur 0751

TABLE TOP/SHELF EDGING (when melamine surface)



Black ABS

STABILIZING PANEL



Black melamine

PING PONG 'NET'



Solid core laminate
black

grID

by BuloDesign



grID

by BuloDesign

grID is a height adjustable modular desk system suited for teamwork, individual working zones, fixed or flexible workstations, sit or stand and all heights in between.

grID is characterised by a clean and minimal approach.

The architectural language is inspired by the rigid minimalism of the De Stijl movement.

TOPS

0.51" thick mdf, finished in Fenix HPL

0.94" thick mdf, finished in veneer

0.98" thick chipboard, finished in melamine

HEIGHTS

Fixed height: 29.13"

Electronically height adjustable: 25.59" - 49.21". EU mains lead included to plug into the floor box.

The telescopic beam of the frame is always black. With height adjustable desks the motor is hidden in the telescopic black beam, operated through a control box and a control panel with display and up and down arrow.

Troubleshooting: the height adjustment can be reset by lowering the desk to its lowest possible height.

Standing desks with fixed height: 44.09"



Control panel with display for height adjustable desks

HPL FENIX

FENIX NTM® is a super opaque nanotech material. It combines elegant aesthetic solutions with state-of-the-art technological performance. The external surface of FENIX NTM® involves the use of nanotechnology that allows thermal healing or superficial micro-scratches. FENIX NTM® has low light reflectivity, is anti-fingerprint and features a very pleasant soft touch. It is highly resistant to scratches, abrasion, rubbing and dry heat. It significantly reduces the bacterial load making its surface hygienic and easy to clean. It is also liquid repellent and mould-proof. FENIX NTM® is available on a maximum depth of 59.06"

SCREENS

A grID table top 31.50" or 35.43" deep can be equipped with a screen, fixed to the table top with L-shaped profiles.

All grID table tops 49.21" deep or deeper can be equipped with a built-in screen on 2 feet through the top

To ensure the correct fittings are made in the top, the type of screen, its position and its width need to be indicated with the grID table. The screen itself has to be ordered separately, see price list Screens

CODE COMPOSITION EXAMPLE: G21S1409E011K3VAL

G	2	1	S	1	4	0	9	E	0	1	1	K	3	V	A	L	
																	position screen (*)
																	screen width (*)
																	type of screen (*)
																	position 1st grommet (*)
																	grommet type (*)
																	finish legs
																	finish top
																	height adjustability
																	depth top (metric abbreviation)
																	width top (metric abbreviation)
																	freestanding desk or start module, ...
																	type of desk (single,double,...)
																	top thickness (metric abbreviation)
																	grID collection

(*) code 0 if no grommet/screen

grID

by BuloDesign

GROMMET POSITIONS

To ensure the correct cutout is made in the top, the type of grommet and its position must be indicated with the grID table. The grommet itself has to be ordered separately, see price list Electrification. The below views are top views and seen from the user's side.

Cutouts 1, 5, 7 and 9 start at 13.78" from the edge.

Cutouts 3 and 8 are positioned centrally.

grID tops 31.50" and 35.43" deep have a central beam underneath the top; positions 7, 8 and 9 are not possible.

grID table top 31.50" or 35.43" deep

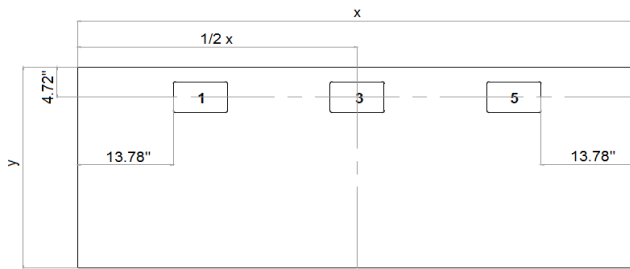

grID table top 49.21" deep or deeper

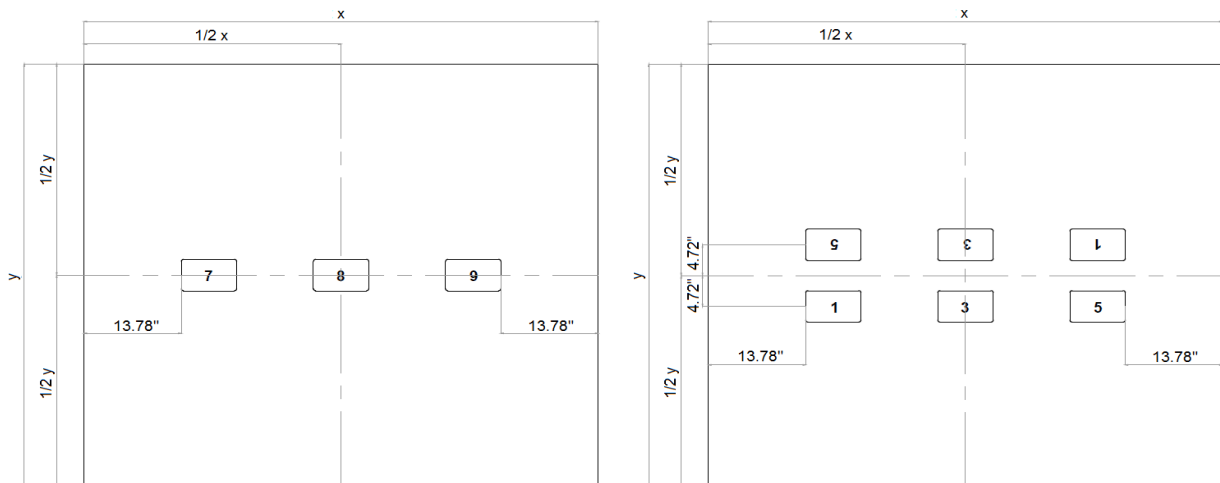

Grommet	Position 1, 3, 5	Position 7, 8, 9
Diam. 2.36"	✓	✓
Diam. 3.15"	✓	✓
Go	✓ (+)	✓
Hub E3		✓
Hub EL		✓
Normal	✓	✓
Point	✓	✓
Style	✓ (++)	✓
Top Access	✓	✓
XXL	✓	✓

(+) 'Go' grommet is not possible on positions 1 and 5 in table tops 31.5" deep.

Position 3 remains possible in 31.5" deep tops.



(++) 'Style' grommets require 9.84" between 2 opposite cutouts (position 3&3)

grID



1. Individual workstations

1.1. Individual, fixed height or electronically height adjustable

List prices

			Fenix hpl		Melamine	Veneer A	Veneer B
	Code		0.51"	Code	0.98"	0.94"	0.94"
1.1.1. Fixed height, 29.73"							
31.50" deep							
	w 57.09" x d 31.50"	G11S1408V*	2.325	G21S1408V*	1.895	2.855	4.055
	w 64.96" x d 31.50"	G11S1608V*	2.465	G21S1608V*	1.900	3.050	4.395
	w 72.83" x d 31.50"	G11S1808V*	2.595	G21S1808V*	1.940	3.205	4.650
	w 80.71" x d 31.50"	G11S2008V*	2.790	G21S2008V*	2.030	3.460	5.030
	w 88.58" x d 31.50"	G11S2208V*	2.920	G21S2208V*	2.075	3.635	5.340
	w 96.46" x d 31.50"	G11S2408V*	3.050	G21S2408V*	2.115	3.815	5.650
35.43" deep							
	w 57.09" x d 35.43"	G11S1409V*	2.445	G21S1409V*	1.935	3.000	4.305
	w 64.96" x d 35.43"	G11S1609V*	2.600	G21S1609V*	1.975	3.205	4.650
	w 72.83" x d 35.43"	G11S1809V*	2.750	G21S1809V*	2.015	3.415	5.005
	w 80.71" x d 35.43"	G11S2009V*	2.955	G21S2009V*	2.120	3.680	5.415
	w 88.58" x d 35.43"	G11S2209V*	3.100	G21S2209V*	2.160	3.890	5.775
	w 96.46" x d 35.43"	G11S2409V*	3.255	G21S2409V*	2.205	4.300	6.475

1.1.2. Electronically height adjustable, 25.59" - 49.21" (++)

31.50" deep							
	w 57.09" x d 31.50"	G11S1408E*	4.060	G21S1408E*	3.630	4.585	5.790
	w 64.96" x d 31.50"	G11S1608E*	4.200	G21S1608E*	3.635	4.785	6.130
	w 72.83" x d 31.50"	G11S1808E*	4.330	G21S1808E*	3.680	4.940	6.385
	w 80.71" x d 31.50"	G11S2008E*	4.540	G21S2008E*	3.785	5.200	6.785
	w 88.58" x d 31.50"	G11S2208E*	4.670	G21S2208E*	3.825	5.390	7.095
	w 96.46" x d 31.50"	G11S2408E*	4.805	G21S2408E*	3.865	5.570	7.405
35.43" deep							
	w 57.09" x d 35.43"	G11S1409E*	4.185	G21S1409E*	3.670	4.740	6.040
	w 64.96" x d 35.43"	G11S1609E*	4.330	G21S1609E*	3.710	4.940	6.385
	w 72.83" x d 35.43"	G11S1809E*	4.485	G21S1809E*	3.750	5.155	6.745
	w 80.71" x d 35.43"	G11S2009E*	4.705	G21S2009E*	3.875	5.430	7.165
	w 88.58" x d 35.43"	G11S2209E*	4.850	G21S2209E*	3.915	5.640	7.525
	w 96.46" x d 35.43"	G11S2409E*	5.005	G21S2409E*	3.955	6.050	8.225

(++) a separate mains lead is required to power the height adjustment motor, see price list electrification

* FINISHES & CODES

1) Top		3) Grommet type		5) Fittings for screen attached to the table top	
0.98" melamine	13 mm hpl Fenix	00 no grommet (skip 4)		000 no screen (skip 6)	
01 lily white	F1 white	E diam. 2.36"	M Style 4	VA screen w 31.10"	
	F2 beige Arizona	G diam. 3.15"	N Style 5	VB screen w 38.98"	
	F3 grigio bromo	I Go	O Style 6	VC screen w 46.85"	
	F4 black	J Normal	X XXL	VD screen w 50.79"	
	F6 blue fes	K Style 2	Y Point	VE screen w 54.72"	
	F7 verde comodoro	L Style 3	Z Top access	VF screen w 58.66"	
	F8 beige luxor			VG screen w 62.60"	
	F9 rosso jaipur			VH screen w 70.47"	
		Upcharge per grommet cutout:		VI screen w 78.35"	
		+ 73		VJ screen w 86.22"	
0.94" veneer A	0.94" veneer B	Price grommet, see price list Electrification		VK screen w 94.09"	
ES ash	ME fossile oak			Upcharge fittings for screen:	
NN walnut	GE fumed oak			+ 73	
NM walnut mismatched	TE teak				
KE cherry	ZE zebrano	4) Grommet position			
EK European oak	PL Santos Rosewood	1 position 1			
EE black lacquered oak	WE wenge	3 position 3			
		5 position 5			
		Positions, see p.101			
				6) Screen position	
	2) Base			L left	M central
1 lily white	4 black				R right
				Price screen, see price list Screens	

Code example: G21S1409E011K3VAL = 3.817

Individual workstations

1.2. For 2 persons, individual tops, fixed height or individually height adjustable

List prices

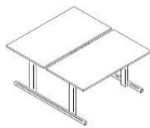
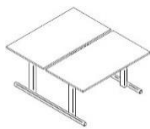
			Fenix hpl			Melamine	Veneer A	Veneer B
		Code	0.51"		Code	0.98"	0.94"	0.94"
1.2.1. Both tops with fixed height 29.73"								
	2 x w 64.96" x d 31.50" = w 64.96" x d 64.96"	G12S1608V*	4.680		G22S1608V*	3.565	5.860	8.545
	2 x w 72.83" x d 31.50" = w 72.83" x d 64.96"	G12S1808V*	4.950		G22S1808V*	3.645	6.165	9.055
	2 x w 72.83" x d 35.43" = w 72.83" x d 72.83"	G12S1809V*	5.260		G22S1809V*	3.790	6.590	9.780
	2 x w 80.71" x d 31.50" = w 80.71" x d 64.96"	G12S2008V*	5.220		G22S2008V*	3.710	6.545	9.710
1.2.2. Both tops electronically height adjustable 25.59" - 49.21" (++)								
	2 x w 64.96" x d 31.50" = w 64.96" x d 64.96"	G12S1608E*	8.150		G22S1608E*	7.035	9.335	12.015
	2 x w 72.83" x d 31.50" = w 72.83" x d 64.96"	G12S1808E*	8.420		G22S1808E*	7.115	9.635	12.530
	2 x w 72.83" x d 35.43" = w 72.83" x d 72.83"	G12S1809E*	8.730		G22S1809E*	7.265	10.060	13.245
	2 x w 80.71" x d 31.50" = w 80.71" x d 64.96"	G12S2008E*	8.680		G22S2008E*	7.175	10.020	13.180

(++) two separate mains leads are required to power the height adjustment motors, see price list Electrification

* FINISHES & CODES



1) Top		3) Grommet type		5) Fittings for screen attached to the table top	
0.98" melamine	13 mm hpl Fenix	000 no grommet (skip 4)		000 no screen (skip 6)	
01 lily white	F1 white	E diam. 2.36"	M Style 4	VA	screen w 31.10"
	F2 beige Arizona	G diam. 3.15"	N Style 5	VB	screen w 38.98"
	F3 grigio bromo	I Go	O Style 6	VC	screen w 46.85"
	F4 black	J Normal	X XXL	VD	screen w 50.79"
	F6 blue fes	K Style 2	Y Point	VE	screen w 54.72"
	F7 verde comodoro	L Style 3	Z Top access	VF	screen w 58.66"
	F8 beige luxor			VG screen w 62.60"	
	F9 rosso jaipur			VH	screen w 70.47"
0.94" veneer A	0.94" veneer B	Upcharge per grommet cutout: + 73		VI	screen w 78.35"
ES ash	ME fossile oak	Price grommet, see price list Electrification		VJ	screen w 86.22"
NN walnut	GE fumed oak			VK	screen w 94.09"
NM walnut mismatched	TE teak			Upcharge fittings for screen: + 73	
KE cherry	ZE zebrano			6) Screen position	
EK European oak	PL Santos Rosewood			L left	M central
EE black lacquered oak	WE wenge				R right
2) Base		4) Grommet position		Price screen, see price list Screens	
1 lily white	4 black	<u>4V) In top 1</u>	<u>4b) In top 2</u>		
		1 position 1	1 position 1		
		3 position 3	3 position 3		
		5 position 5	5 position 5		
		Positions, see p.101			

Code example: G22S1608E014000VGM = 7.108

2. Double workstation

For 2 persons, 1 top, fixed height or height adjustable

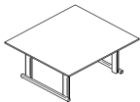
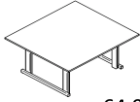
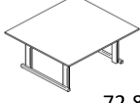
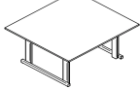
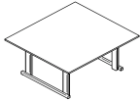
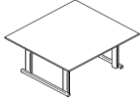
List prices

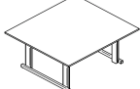
	Code	Fenix hpl 0.51"		Code	Melamine 0.98"	Veneer A 0.94"	Veneer B 0.94"
2.1. Fixed height 29.13"							
49.21" deep							
	w 57.09" x d 49.21"	G15S1412V*	4.030	G25S1412V*	3.215	4.680	6.410
	w 64.96" x d 49.21"	G15S1612V*	4.215	G25S1612V*	3.280	5.065	7.060
	w 72.83" x d 49.21"	G15S1812V*	4.430	G25S1812V*	3.350	5.595	7.965
	w 80.71" x d 49.21"	G15S2012V*	4.900	G25S2012V*	3.525	6.040	8.635
57.09" deep							
	w 57.09" x d 57.09"	G15S1414V*	4.405	G25S1414V*	3.295	5.335	7.515
	w 64.96" x d 57.09"	G15S1614V*	4.615	G25S1614V*	3.360	5.700	8.130
	w 72.83" x d 57.09"	G15S1814V*	4.885	G25S1814V*	3.440	6.065	8.770
	w 80.71" x d 57.09"	G15S2014V*	5.275	G25S2014V*	3.615	6.590	9.555
64.96" deep							
	w 57.09" x d 64.96"	G15S1416V*	4.615	G25S1416V*	3.360	5.700	8.130
	w 64.96" x d 64.96"	G15S1616V*	-	G25S1616V*	3.440	6.125	8.860
	w 72.83" x d 64.96"	G15S1816V*	-	G25S1816V*	3.530	6.565	9.610
	w 80.71" x d 64.96"	G15S2016V*	-	G25S2016V*	3.720	7.125	10.465
72.83" deep							
	w 57.09" x d 72.83"	G15S1418V*	4.885	G25S1418V*	3.440	6.065	8.770
	w 64.96" x d 72.83"	G15S1618V*	-	G25S1618V*	3.530	6.565	9.610
	w 72.83" x d 72.83"	G15S1818V*	-	G25S1818V*	3.620	7.050	10.435
	w 80.71" x d 72.83"	G15S2018V*	-	G25S2018V*	3.835	7.665	11.390
2.2. Electronically height adjustable 25.59" - 49.21" (++)							
49.21" deep							
	w 57.09" x d 49.21"	G15S1412E*	7.450	G25S1412E*	7.005	8.470	10.200
	w 64.96" x d 49.21"	G15S1612E*	7.640	G25S1612E*	7.070	8.860	10.860
	w 72.83" x d 49.21"	G15S1812E*	7.850	G25S1812E*	7.140	9.390	11.755
	w 80.71" x d 49.21"	G15S2012E*	8.195	G25S2012E*	7.355	9.870	12.465
57.09" deep							
	w 57.09" x d 57.09"	G15S1414E*	7.825	G25S1414E*	7.085	9.120	11.305
	w 64.96" x d 57.09"	G15S1614E*	8.040	G25S1614E*	7.150	9.490	11.925
	w 72.83" x d 57.09"	G15S1814E*	8.300	G25S1814E*	7.230	9.865	12.560
	w 80.71" x d 57.09"	G15S2014E*	8.570	G25S2014E*	7.445	10.410	13.375
64.96" deep							
	w 57.09" x d 64.96"	G15S1416E*	8.040	G25S1416E*	7.150	9.490	11.925
	w 64.96" x d 64.96"	G15S1616E*	-	G25S1616E*	7.230	9.915	12.650
	w 72.83" x d 64.96"	G15S1816E*	-	G25S1816E*	7.320	10.360	13.400
	w 80.71" x d 64.96"	G15S2016E*	-	G25S2016E*	7.550	10.950	14.300
72.83" deep							
	w 57.09" x d 72.83"	G15S1418E*	8.300	G25S1418E*	7.230	9.865	12.560
	w 64.96" x d 72.83"	G15S1618E*	-	G25S1618E*	7.320	10.360	13.400
	w 72.83" x d 72.83"	G15S1818E*	-	G25S1818E*	7.420	10.840	14.225
	w 80.71" x d 72.83"	G15S2018E*	-	G25S2018E*	7.665	11.495	15.210

(++) a separate mains lead is required to power the height adjustment motor, see price list electrification

* FINISHES & CODES

1) Top		3) Grommet type		5) Fitting for central screen	
0.98" melamine	13 mm hpl Fenix	00 no grommet (skip 4)		000 no screen (skip 6)	
01 lily white	F1 white	E diam. 2.36"	M Style 4	TA screen w 31.10"	
	F2 beige Arizona	G diam. 3.15"	N Style 5	TB screen w 38.98"	
	F3 grigio bromo	H HUB (+)	O Style 6	TC screen w 46.85"	
	F4 black	I Go	X XXL	TD screen w 50.79"	
	F6 blue fes	J Normal	Y Point	TE screen w 54.72"	
	F7 verde comodoro	K Style 2	Z Top access	TF screen w 58.66"	
	F8 beige luxor	L Style 3		TG screen w 62.60"	
	F9 rosso jaipur			TH screen w 70.47"	
		Upcharge per grommet cutout: + 73		TI screen w 78.35"	
		Price grommet, see price list Electrification		Upcharge fittings screen: + 73	
0.94" veneer A	0.94" veneer B	4) Positions for 2 grommets		6) Screen position	
ES ash	ME fossile oak	Grommet 1	Grommet 2	L left	M central R right
NN walnut	GE fumed oak	1 position 1	1 position 1	Price screen, see price list Screens	
NM walnut mismatched	TE teak	3 position 3	3 position 3		
KE cherry	ZE zebrano	5 position 5	5 position 5		
EK European oak	PL Santos Rosewood	7 position 7	9 position 9		
EE black lacquered oak	WE wenge	or Positions for 1 central grommet			
		70 position 7			
		80 position 8	Positions, see p.101		
		90 position 9	(+) only on positions 7, 8 or 9		

Code example: G15S1414VF44H80TBM = 4.552

grID

3. Meeting tables

Height adjustable, 25.59" - 49.21"

List prices

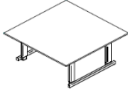
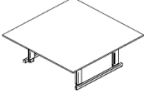
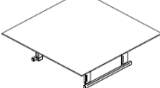
		Code	Fenix hpl 0.51"		Code	Melamine 0.98"	Veneer A 0.94"	Veneer B 0.94"
57.09" deep								
	w 57.09" x d 57.09"	G1MT1414E*	7.115		G2MT1414E*	6.000	8.045	10.225
	w 64.96" x d 57.09"	G1MT1614E*	7.330		G2MT1614E*	6.075	8.405	10.840
	w 72.83" x d 57.09"	G1MT1814E*	7.590		G2MT1814E*	6.155	8.780	11.480
	w 80.71" x d 57.09"	G1MT2014E*	7.860		G2MT2014E*	6.325	9.300	12.270
64.96" deep								
	w 57.09" x d 64.96"	G1MT1416E*	7.330		G2MT1416E*	6.075	8.405	10.840
	w 64.96" x d 64.96"	G1MT1616E*	-		G2MT1616E*	6.155	8.835	11.575
	w 72.83" x d 64.96"	G1MT1816E*	-		G2MT1816E*	6.245	9.275	12.325
	w 80.71" x d 64.96"	G1MT2016E*	-		G2MT2016E*	6.435	9.840	13.180
72.83" deep								
	w 57.09" x d 72.83"	G1MT1418E*	7.590		G2MT1418E*	6.155	8.780	11.480
	w 64.96" x d 72.83"	G1MT1618E*	-		G2MT1618E*	6.245	9.275	12.325
	w 72.83" x d 72.83"	G1MT1818E*	-		G2MT1818E*	6.335	9.765	13.150
	w 80.71" x d 72.83"	G1MT2018E*	-		G2MT2018E*	6.545	10.375	14.100





* FINISHES & CODES

1) Top		3) Grommet type		5) Fitting for central screen	
0.98" melamine	13 mm hpl Fenix	00 no grommet (skip 4)		000 no screen (skip 6)	
01 lily white	F1 white	E diam. 2.36"	M Style 4	TA	screen w 31.10"
	F2 beige Arizona	G diam. 3.15"	N Style 5	TB	screen w 38.98"
	F3 grigio bromo	H HUB (+)	O Style 6	TC	screen w 46.85"
	F4 black	I Go	X XXL	TD	screen w 50.79"
	F6 blue fes	J Normal	Y Point	TE	screen w 54.72"
	F7 verde comodo	K Style 2	Z Top access	TF	screen w 58.66"
	F8 beige luxor	L Style 3		TG	screen w 62.60"
	F9 rosso jaipur			TH	screen w 70.47"
				TI	screen w 78.35"
		Upcharge per grommet cutout: + 73		Upcharge fittings screen: + 73	
		Price grommet, see price list Electrification			
0.94" veneer A	0.94" veneer B	4) Positions for 2 grommets		6) Screen position	
ES ash	ME fossile oak	Grommet 1	Grommet 2	L left	M central R right
NN walnut	GE fumed oak	1 position 1	1 position 1	Price screen, see price list Screens	
NM walnut mismatched	TE teak	3 position 3	3 position 3		
KE cherry	ZE zebrano	5 position 5	5 position 5		
EK European oak	PL Santos Rosewood	7 position 7	9 position 9		
EE black lacquered oak	WE wenge	or	Positions for 1 central grommet		
		70 position 7			
		80 position 8	Positions, see p.101		
		90 position 9	(+) only on positions 7, 8 or 9		
	2) Base				
	1 lily white				
	4 black				

Code example: G2MT1414E011Y80000 = 6.073

4. Accessories

Cable management

		Finish	Code	List prices
4.1. Vertical cable duct in lacquered metal				
		lily white	GRDCAVE01	150
		black	GRDCAVE04	150
4.2. Vertical, flexible cable duct				
	For workstation with fixed height (29.13")	grey	GRDCSA08	255
	For electronically height adjustable workstation	grey	GRDCSC08	295
4.3. Cable net				
	w 35.43" x d 16.14" for single tops	grey	ELCCN09SI08	215
		black	ELCCN09SI04	215
	w 35.43" x d 29.52" for double tops	grey	ELCCN09DO08	225
		black	ELCCN09SDO04	225
4.4. Cable clamps				
 	Single cable clamp 4.13", grey		ELCKK02	NET PRICES 22
	Double cable clamp 8.27", black		ELCKK04	22
4.5. Grommets				
See price list Electrification				

MELAMINE



Lily white

FENIX HPL



White 0029

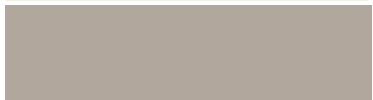

Beige Arizona 0748

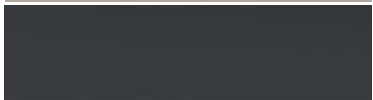

Grigio bromo 0724



Black 0720



Blu fes 0754



Verde comodoro 0750



Beige luxor 0719



Rosso jaipur 0751

BASE

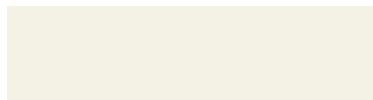

Lily white lacquered
NCS S0502-Y



Black lacquered
RAL 9005

VENEER CATEGORY A



Ash



Walnut



Walnut mismatched



Cherry



European oak



Black lacquered
European oak

VENEER CATEGORY B



Fossile oak



Fumed oak

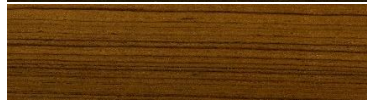

Teak



Zebrano



Santos rose wood



Wenge

H₂O

by Claire Bataille & Paul ibens



H2O

by Claire Bataille & Paul ibens

GROMMET POSITIONS

To ensure the correct cutout is made in the top, the type of grommet and its position must be indicated with the H2O table. The grommet itself has to be ordered separately, see price list Electrification. The below views are top views and seen from the user's side.

The cutouts 1, 2, 5, 6, 7 and 9 start at 13.78" from the edge. The cutouts 3, 4 and 8 are positioned centrally.

For H2O table 31.50", 39.37" or 47.24" deep

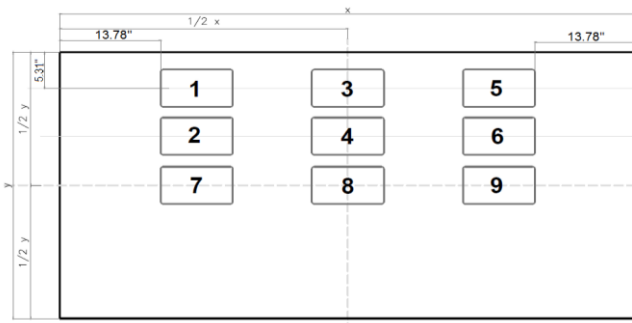

For H2O table/bench/meeting table as from 55.12" deep

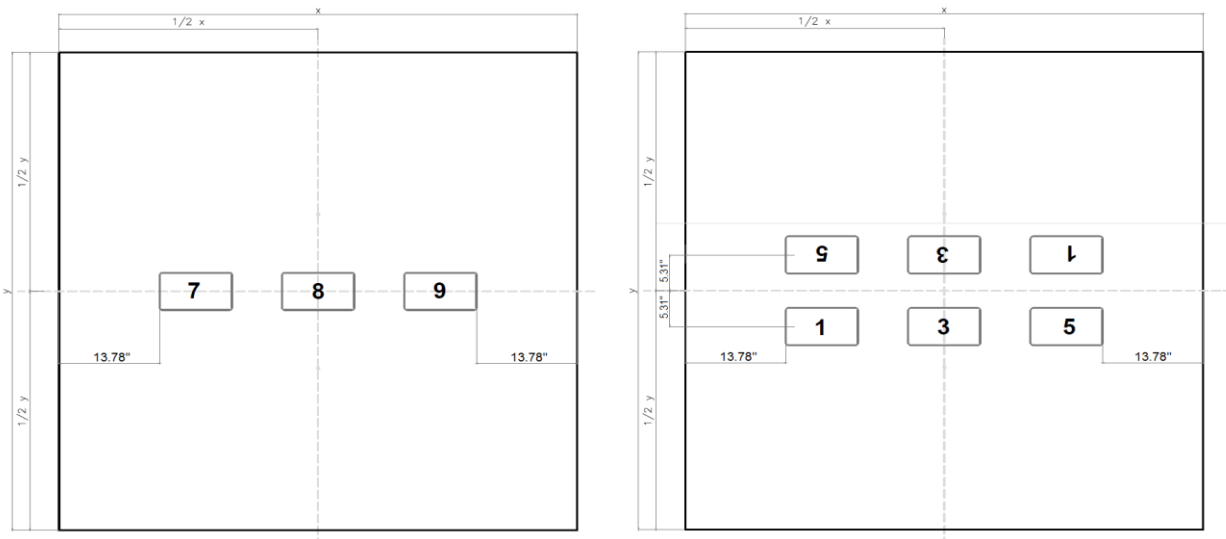

Grommet	Position 1, 2, 3, 4, 5, 6	Position 7, 8, 9
Diam. 2.36"	✓	✓
Diam. 3.15"	✓	✓
Go	✓	✓
Hub E3		✓
Hub EL		✓
Normal	✓	✓
Point	✓	✓
Style (*)	✓	✓
Top Access	✓	✓
XXL	✓	✓

(*) 'Style' grommets require 8.27" between 2 opposite cutouts

EXCLUSIONS:

Positions 2 and 6 are not possible in start, connecting and end modules.

Positions 7, 8 and 9 are not possible in tables on 4 legs that are 94.49" wide or wider AND 31.50" deep.

Positions 7, 8 and 9 are not possible for HUB E3 and HUB EL grommets in tables on 4 legs that are 94.49" wide or wider AND 39.37" deep.

Positions 7, 8 and 9 are not possible in combination with a built-in screen.



Positions 7, 8 and 9 are not possible in combination with a built-in screen.

H2O

1. Single tables

List prices

1.1. Top in melamine, Fenix hpl or veneer

	Code	Melamine	Fenix hpl	Veneer A		Veneer B		
		0.71"	0.51"	0.71"	chamf.	0.71"	chamf.	
31.50" deep								
	w 31.50" x d 31.50"	H0808S *	2.755	3.425	3.705	3.995	4.935	5.145
	w 55.12" x d 31.50"	H1408S *	3.020	4.020	4.640	5.160	6.475	6.865
	w 62.99" x d 31.50"	H1608S *	3.115	4.215	4.965	5.555	6.985	7.420
	w 70.87" x d 31.50"	H1808S *	3.165	4.365	5.235	5.910	7.445	7.955
	w 78.74" x d 31.50"	H2008S *	3.240	4.550	5.535	6.280	7.955	8.485
	w 86.61" x d 31.50"	H2208S *	3.335	4.770	5.860	6.670	8.470	9.075
	w 94.49" x d 31.50"	H2408S *	3.850	5.420	6.595	7.470	9.390	10.070
	w 102.36" x d 31.50"	H2608S *	4.120	5.805	7.100	8.030	10.090	10.825
39.37" deep								
	w 39.37" x d 39.37"	H1010S *	2.920	3.840	4.370	4.835	6.035	6.375
	w 55.12" x d 39.37"	H1410S *	3.115	4.300	5.120	5.765	7.225	7.710
	w 62.99" x d 39.37"	H1610S *	3.190	4.510	5.485	6.205	7.810	8.375
	w 70.87" x d 39.37"	H1810S *	3.260	4.740	5.840	6.670	8.395	9.000
	w 78.74" x d 39.37"	H2010S *	3.360	5.045	6.230	7.100	8.470	9.075
	w 86.61" x d 39.37"	H2210S *	3.505	5.355	6.915	7.955	9.975	9.685
	w 94.49" x d 39.37"	H2410S *	4.190	6.215	7.885	8.510	10.385	11.215
	w 102.36" x d 39.37"	H2610S *	4.355	6.530	8.375	9.610	11.940	12.910
47.24" deep								
	w 47.24" x d 47.24"	H1212S *	3.090	4.280	5.160	5.815	7.295	7.785
	w 55.12" x d 47.24"	H1412S *	3.215	4.605	5.505	6.375	8.005	8.560
	w 62.99" x d 47.24"	H1612S *	3.825	5.315	6.570	7.420	9.170	9.855
	w 70.87" x d 47.24"	H1812S *	3.435	5.400	6.765	7.810	9.760	10.555
	w 78.74" x d 47.24"	H2012S *	3.530	5.660	7.225	8.375	10.460	11.355
	w 86.61" x d 47.24"	H2212S *	3.630	6.025	7.690	8.950	11.190	12.185
	w 94.49" x d 47.24"	H2412S *	4.330	6.800	8.755	9.945	12.530	13.620
	w 102.36" x d 47.24"	H2612S *	4.500	7.035	9.295	10.775	13.330	14.495

* FINISHES & CODES



1) Top		2) Legs		4) Grommet position		5) Fittings for screen	
0.71" melamine	0.51" hpl Fenix	1 lily white lacquered	4) Grommet 1	<u>attached to table top</u>			
1801 lily white	13F1 white	4 black lacquered	1 position 1	0000 no screen (skip 6)			
	13F2 beige Arizona	5 grey-green lacquered	2 position 2	OVA screen w 31.10"			
	13F3 grigio bromo	upcharge for 4 legs: + 620	3 position 3	OVB screen w 38.98"			
	13F4 black	7 bronze color anodized	4 position 4	OVC screen w 46.85"			
	13F6 blue fes	upcharge for 4 legs: + 1.190	5 position 5	OVD screen w 50.79"			
	13F7 verde comodoro	8 natural anodized	6 position 6	OVE screen w 54.72"			
	13F8 beige luxor	9 beige luxor matching	7 position 7 (++)	OVF screen w 58.66"			
	13F9 rosso jaipur	lacquered	8 position 8 (++)	OVG screen w 62.60"			
		upcharge for 4 legs: + 1.190	9 position 9 (++)	OVH screen w 70.47"			
				OVI screen w 78.35"			
0.71" veneer A	0.71" veneer B	3) Grommet type	4b) Grommet 2	OVJ screen w 86.22"			
18ES ash	18ME fossile oak	000 without grommets (skip 4)	0 no 2nd grommet	OVK screen w 94.09"			
18NN walnut	18GE fumed oak	E diam. 2.36" M Style 4	1 position 1	OVL screen w 101.97"			
18NM walnut mismatched	18TE teak	G diam. 3.15" N Style 5	2 position 2	Upcharge fittings + 73			
18KE cherry	18ZE zebrano	H HUB (+) O Style 6	3 position 3				
18EK European oak	18PL Santos Rosewood	I Go X XXL	4 position 4	<u>6) position screen</u>			
18EE black lacquered oak	18WE wenge	J Normal Y Point	5 position 5	L left M central R right			
		K Style 2 Z Top access	6 position 6				
1.06"/0.39" veneer A	1.06"/0.39" veneer B	L Style 3	7 position 7 (++)	Price screen, see			
27ES ash	27ME fossile oak		8 position 8 (++)	price list Screens			
27NN walnut	27GE fumed oak	Upcharge per grommet cutout:	9 position 9 (++)				
27NM walnut mismatched	27TE teak	+ 73					
27KE cherry	27ZE zebrano	Grommet price, see price list		Positions, see p.111			
27EK European oak	27PL Santos Rosewood	Electrification		(+) only on 7, 8 or 9			
27EE black lacquered oak	27WE wenge			(++) see exclusions p.111			

Code example: H2010S13F14J300VIM = 5.118

H2O

Single tables

List prices

		Code	Melamine 0.71"	Fenix hpl 0.51"	Veneer A		Veneer B	
					0.71"	chamf.	0.71"	chamf.
55.12" deep								
	w 55.12" x d 55.12"	H1414S *	3.800	5.380	6.840	7.760	9.560	10.310
	w 62.99" x d 55.12"	H1614S *	3.945	6.220	7.395	8.470	10.435	11.290
	w 70.87" x d 55.12"	H1814S *	4.120	6.610	7.980	9.195	11.330	12.260
	w 78.74" x d 55.12"	H2014S *	4.215	6.325	8.510	9.855	12.140	13.180
	w 86.61" x d 55.12"	H2214S *	4.550	7.255	9.270	10.730	13.180	14.345
	w 94.49" x d 55.12"	H2414S *	4.745	7.560	9.660	11.265	13.865	15.105
62.99" deep								
	w 55.12" x d 62.99"	H1416S *	3.925	-	7.370	8.445	10.410	11.265
	w 62.99" x d 62.99"	H1616S *	4.045	-	7.980	8.535	11.005	12.285
	w 70.87" x d 62.99"	H1816S *	4.240	-	8.660	9.075	12.335	13.400
	w 78.74" x d 62.99"	H2016S *	4.355	-	9.245	9.855	13.255	14.470
	w 86.61" x d 62.99"	H2216S *	4.500	-	9.880	11.550	14.200	15.520
	w 94.49" x d 62.99"	H2416S *	4.845	-	10.730	12.530	15.350	16.785
70.87" deep								
	w 55.12" x d 70.87"	H1418S *	3.995	-	7.860	9.075	11.215	12.140
	w 62.99" x d 70.87"	H1618S *	4.165	-	8.585	9.945	12.260	13.330
	w 70.87" x d 70.87"	H1818S *	4.305	-	9.270	10.800	13.305	14.520
	w 78.74" x d 70.87"	H2018S *	4.475	-	9.995	11.700	14.345	15.710
	w 86.61" x d 70.87"	H2218S *	4.720	-	10.775	12.650	15.375	16.970

Fenix hpl can only be applied on tops up to 55.12" deep.

* FINISHES & CODES

1) Top		2) Legs		4) Grommet position		5) Fittings for built-in screen on 2 feet	
0.71" melamine		0.51" hpl Fenix		4a) Grommet 1		0000 no screen (skip 6)	
1801	lily white	13F1	lily white	1	position 1	OTA screen w 31.10"	
		13F2	beige Arizona	2	position 2	OTB screen w 38.98"	
		13F3	grigio bromo	3	position 3	OTC screen w 46.85"	
		13F4	black	4	position 4	OTD screen w 50.79"	
		13F6	blue fes	5	position 5	OTE screen w 54.72"	
		13F7	verde comodoro	6	position 6	OTF screen w 58.66"	
		13F8	beige luxor	7	position 7	OTG screen w 62.60"	
		13F9	rosso jaipur	8	position 8	OTH screen w 70.47"	
				9	position 9	OTI screen w 78.35"	
0.71" veneer A		0.71" veneer B		4b) Grommet 2		OTJ screen w 86.22"	
18ES	ash	18ME	fossile oak	0 no 2nd grommet		Upcharge fittings + 73	
18NN	walnut	18GE	fumed oak	1 position 1			
18NM	walnut mismatched	18TE	teak	2 position 2		<u>6) position screen</u>	
18KE	cherry	18ZE	zebrano	3 position 3		L left M central R right	
18EK	European oak	18PL	Santos Rosewood	4 position 4			
18EE	black lacquered oak	18WE	wenge	5 position 5		Price screen, see	
1.06"/0.39" veneer A		1.06"/0.39" veneer B		6 position 6		price list Screens	
27ES	ash	27ME	fossile oak	7 position 7			
27NN	walnut	27GE	fumed oak	8 position 8			
27NM	walnut mismatched	27TE	teak	9 position 9			
27KE	cherry	27ZE	zebrano			Positions, see p.111	
27EK	European oak	27PL	Santos Rosewood			(+) only on 7, 8 or 9	
27EE	black lacquered oak	27WE	wenge				
				3) Grommet type			
				000 without grommets (skip 4)			
				E diam. 2.36"	M Style 4		
				G diam. 3.15"	N Style 5		
				H HUB (+)	O Style 6		
				I Go	X XXL		
				J Normal	Y Point		
				K Style 2	Z Top access		
				L Style 3			
				Upcharge per grommet cutout:			
				+ 73			
				Grommet price, see price list			
				Electrification			

Code example: H1816S18NN4H800000 = 8.660

H2O

2. Benches/meeting tables, d 39.37"

List prices

Tops in melamine, Fenix hpl or veneer

Code	Melamine	Fenix hpl	Veneer A		Veneer B	
	0.71"	0.51"	0.71"	chamf.	0.71"	chamf.

A bench is formed by at least 1 start module + 1 end module. One or more connecting modules can be added.

39.37" deep

Start module



w 55.12" x d 39.37"	H1410B *	4.405	5.715	6.410	7.060	8.510	9.000
w 62.99" x d 39.37"	H1610B *	4.500	5.960	6.800	7.515	9.120	9.685
w 70.87" x d 39.37"	H1810B *	4.575	6.150	7.150	7.980	9.710	10.310
w 78.74" x d 39.37"	H2010B *	4.670	6.370	7.540	8.420	10.290	10.995
w 86.61" x d 39.37"	H2210B *	4.820	6.775	8.225	9.270	11.305	12.140
w 94.49" x d 39.37"	H2410B *	5.505	7.655	9.195	9.830	11.700	12.530
w 102.36" x d 39.37"	H2610B *	5.650	7.950	9.660	10.900	13.230	14.200

Connecting module



w 55.12" x d 39.37"	H1410M *	3.580	4.805	5.585	6.230	7.690	8.175
w 62.99" x d 39.37"	H1610M *	3.655	5.025	5.950	6.670	8.275	8.830
w 70.87" x d 39.37"	H1810M *	3.725	5.210	6.300	7.125	8.855	9.465
w 78.74" x d 39.37"	H2010M *	3.825	5.440	6.695	7.565	9.440	10.140
w 86.61" x d 39.37"	H2210M *	3.970	5.840	7.370	8.420	10.460	10.850
w 94.49" x d 39.37"	H2410M *	4.650	6.720	8.350	8.975	11.290	11.675
w 102.36" x d 39.37"	H2610M *	4.820	7.035	8.830	10.070	12.405	13.375

End module



w 55.12" x d 39.37"	H1410E *	2.275	3.375	4.280	4.935	6.385	6.875
w 62.99" x d 39.37"	H1610E *	2.365	3.580	4.665	5.380	6.985	7.540
w 70.87" x d 39.37"	H1810E *	2.440	3.855	5.015	5.840	7.565	8.175
w 78.74" x d 39.37"	H2010E *	2.535	4.165	5.405	6.280	8.150	8.855
w 86.61" x d 39.37"	H2210E *	2.685	4.475	6.080	7.125	9.170	9.560
w 94.49" x d 39.37"	H2410E *	3.360	5.300	7.060	7.690	9.995	10.385
w 102.36" x d 39.37"	H2610E *	3.530	5.625	7.540	8.780	11.120	12.090

With 1.06"/0.39" veneer tops, the adjacent edges are straight, the other edges are chamfered.

* FINISHES & CODES



1) Top		2) Legs		4) Grommet position		5) Fittings for screen	
0.71" melamine	0.51" hpl Fenix	1 lily white lacquered		4a) Grommet 1	<u>attached to table top</u>		
1801 lily white	13F1 lily white	4 black lacquered		1 position 1	0000 no screen (skip 6)		
	13F2 beige Arizona	5 grey-green lacquered		3 position 3	OVA screen w 31.10"		
	13F3 grigio bromo	upcharge for 2 legs: + 310		4 position 4	OVB screen w 38.98"		
	13F4 black	7 bronze color anodized		5 position 5	OVC screen w 46.85"		
	13F6 blue fes	upcharge for 2 legs: + 595		7 position 7	OVD screen w 50.79"		
	13F7 verde comodoro	8 natural anodized		8 position 8	OVE screen w 54.72"		
	13F8 beige luxor	9 beige luxor matching		9 position 9	OVF screen w 58.66"		
	13F9 rosso jaipur	lacquered			OVG screen w 62.60"		
		upcharge for 2 legs: + 595		4b) Grommet 2	OVI screen w 70.47"		
				0 no 2nd grommet	OVL screen w 78.35"		
0.71" veneer A	0.71" veneer B	3) Grommet type		1 position 1	OVI screen w 86.22"		
18ES ash	18ME fossile oak	000 without grommets (skip 4)		3 position 3	OVK screen w 94.09"		
18NN walnut	18GE fumed oak	E diam. 2.36" M Style 4		4 position 4	OVL screen w 101.97"		
18NM walnut mismatched	18TE teak	G diam. 3.15" N Style 5		5 position 5	Upcharge fittings + 73		
18KE cherry	18ZE zebrano	H HUB (+) O Style 6		7 position 7			
18EK European oak	18PL Santos Rosewood	I Go X XXL		8 position 8			
18EE black lacquered oak	18WE wenge	J Normal Y Point		9 position 9			
		K Style 2 Z Top access					
		L Style 3					
1.06"/0.39" veneer A	1.06"/0.39" veneer B			Positions, see p.111	Price screen, see		
27ES ash	27ME fossile oak			(+) only on 7, 8 or 9	price list Screens		
27NN walnut	27GE fumed oak						
27NM walnut mismatched	27TE teak	Upcharge per grommet cutout:					
27KE cherry	27ZE zebrano	+ 73					
27EK European oak	27PL Santos Rosewood	Grommet price, see price list Electrification					
27EE black lacquered oak	27WE wenge						

Code example: H1810B180110000VBL + H1810E180110000VBL = 7.162

H2O

Benches/meeting tables, d 47.24"

List prices

Code	Melamine		Fenix hpl		Veneer A		Veneer B	
	0.71"	0.51"	0.71"	0.51"	0.71" chamf.	0.71" chamf.	0.71" chamf.	0.71" chamf.
A bench is formed by at least 1 start module + 1 end module. One or more connecting modules can be added.								
47.24" deep								
Start module								
	w 55.12" x d 47.24"	H1412B *	4.525	6.025	6.815	7.690	9.320	9.880
	w 62.99" x d 47.24"	H1612B *	4.720	6.635	7.860	8.705	10.460	11.145
	w 70.87" x d 47.24"	H1812B *	4.820	6.815	8.055	9.100	11.045	11.845
	w 78.74" x d 47.24"	H2012B *	4.940	6.775	8.510	9.660	11.745	12.650
	w 86.61" x d 47.24"	H2212B *	5.115	7.140	9.000	10.265	12.505	13.500
	w 94.49" x d 47.24"	H2412B *	5.650	8.135	10.070	11.265	13.840	14.935
	w 102.36" x d 47.24"	H2612B *	5.815	8.485	10.605	12.090	14.640	15.805
Connecting module								
	w 55.12" x d 47.24"	H1412M *	3.680	5.090	5.960	6.840	8.470	9.025
	w 62.99" x d 47.24"	H1612M *	3.800	5.730	7.035	7.885	9.635	10.310
	w 70.87" x d 47.24"	H1812M *	3.900	5.905	7.225	8.275	10.840	11.020
	w 78.74" x d 47.24"	H2012M *	3.995	5.995	7.690	8.830	10.925	11.820
	w 86.61" x d 47.24"	H2212M *	4.095	6.140	8.150	9.415	11.650	12.650
	w 94.49" x d 47.24"	H2412M *	4.795	7.200	9.220	10.410	12.985	14.085
	w 102.36" x d 47.24"	H2612M *	4.965	7.550	9.760	11.240	13.790	14.960
End module								
	w 55.12" x d 47.24"	H1412E *	2.390	3.725	4.670	5.555	7.175	7.735
	w 62.99" x d 47.24"	H1612E *	2.610	4.430	5.740	6.595	8.350	9.025
	w 70.87" x d 47.24"	H1812E *	2.710	4.420	5.935	6.985	8.925	9.735
	w 78.74" x d 47.24"	H2012E *	2.805	4.780	6.400	7.540	9.635	10.530
	w 86.61" x d 47.24"	H2212E *	2.995	5.145	6.865	8.130	10.360	11.355
	w 94.49" x d 47.24"	H2412E *	3.505	5.880	7.930	9.120	11.700	12.790
	w 102.36" x d 47.24"	H2612E *	3.630	6.105	8.420	9.895	12.455	13.620

With 1.06"/0.39" veneer tops, the adjacent edges are straight, the other edges are chamfered.

* FINISHES & CODES

1) Top		2) Legs		4) Grommet position		5) Fittings for built-in screen on 2 feet	
0.71" melamine	0.51" hpl Fenix	1 lily white lacquered	4a) Grommet 1	0000 no screen (skip 6)			
1801 white	13F1 lily white	4 black lacquered	1 position 1	OTA screen w 31.10"			
	13F2 beige Arizona	5 grey-green lacquered	3 position 3	OTB screen w 38.98"			
	13F3 grigio bromo	upcharge for 2 legs: + 310	4 position 4	OTC screen w 46.85"			
	13F4 black	7 bronze color anodized	5 position 5	OTD screen w 50.79"			
	13F6 blue fes	upcharge for 2 legs: + 595	7 position 7	OTE screen w 54.72"			
	13F7 verde comodoro	8 natural anodized	8 position 8	OTF screen w 58.66"			
	13F8 beige luxor	9 beige luxor matching	9 position 9	OTG screen w 62.60"			
	13F9 rosso jaipur	upcharge for 2 legs: + 595	4b) Grommet 2	OTH screen w 70.47"			
			0 no 2nd grommet	OTI screen w 78.35"			
0.71" veneer A	0.71" veneer B	3) Grommet type		OTJ screen w 86.22"			
18ES ash	18ME fossile oak	000 without grommets (skip 4)	1 position 1	OTK screen w 94.09"			
18NN walnut	18GE fumed oak	E diam. 2.36" M Style 4	3 position 3	OTL screen w 101.97"			
18NM walnut mismatched	18TE teak	G diam. 3.15" N Style 5	4 position 4	Upcharge fittings + 73			
18KE cherry	18ZE zebrano	H HUB (+) O Style 6	5 position 5				
18EK European oak	18PL Santos Rosewood	I Go X XXL	7 position 7				
18EE black lacquered oak	18WE wenge	J Normal Y Point	8 position 8				
		K Style 2 Z Top access	9 position 9				
		L Style 3					
1.06"/0.39" veneer A	1.06"/0.39" veneer B			6) position screen			
27ES ash	27ME fossile oak			L left M central R right			
27NN walnut	27GE fumed oak			Price screen, see price list Screens			
27NM walnut mismatched	27TE teak	Upcharge per grommet cutout: + 73					
27KE cherry	27ZE zebrano	Grommet price, see price list Electrification					
27EK European oak	27PL Santos Rosewood						
27EE black lacquered oak	27WE wenge						

Code example:H2012B18018G800000 + H2012E18018G800000 = 7.745

H2O

Benches/meeting tables, d 55.12"

List prices

Code	Melamine	Fenix hpl	Veneer A		Veneer B	
	0.71"	0.51"	0.71"	chamf.	0.71"	chamf.

A bench is formed by at least 1 start module + 1 end module. One or more connecting modules can be added.

55.12" deep

Start module



Code	Dimensions	Melamine	Fenix hpl	Veneer A	Veneer B
H1414B *	w 55.12" x d 55.12"	5.135	7.410	8.175	9.100
H1614B *	w 62.99" x d 55.12"	5.310	8.260	8.755	9.830
H1814B *	w 70.87" x d 55.12"	5.505	8.365	9.365	10.580
H2014B *	w 78.74" x d 55.12"	5.600	8.640	9.895	11.240
H2214B *	w 86.61" x d 55.12"	5.935	9.285	10.655	11.420
H2414B *	w 94.49" x d 55.12"	5.885	9.595	11.045	12.650

Connecting module



Code	Dimensions	Melamine	Fenix hpl	Veneer A	Veneer B
H1414M *	w 55.12" x d 55.12"	4.305	5.660	7.345	8.275
H1614M *	w 62.99" x d 55.12"	4.475	6.505	7.930	9.000
H1814M *	w 70.87" x d 55.12"	4.670	6.610	8.535	9.760
H2014M *	w 78.74" x d 55.12"	4.745	6.890	9.050	10.385
H2214M *	w 86.61" x d 55.12"	5.065	7.535	9.805	11.265
H2414M *	w 94.49" x d 55.12"	5.090	7.845	10.215	11.820

End module



Code	Dimensions	Melamine	Fenix hpl	Veneer A	Veneer B
H1414E *	w 55.12" x d 55.12"	2.920	4.135	5.960	6.890
H1614E *	w 62.99" x d 55.12"	3.115	4.980	6.570	7.640
H1814E *	w 70.87" x d 55.12"	3.285	5.365	7.150	8.375
H2014E *	w 78.74" x d 55.12"	3.385	5.315	7.690	9.025
H2214E *	w 86.61" x d 55.12"	3.680	6.150	8.445	9.895
H2414E *	w 94.49" x d 55.12"	3.725	6.555	8.830	10.435

With 1.06"/0.39" veneer tops, the adjacent edges are straight, the other edges are chamfered.

* FINISHES & CODES



1) Top		2) Legs		4) Grommet position		5) Fittings for built-in screen on 2 feet	
0.71" melamine	0.51" hpl Fenix	1 lily white lacquered		4a) Grommet 1		0000 no screen (skip 6)	
1801 lily white	13F1 white	4 black lacquered		1 position 1		OTA screen w 31.10"	
	13F2 beige Arizona	5 grey-green lacquered	upcharge for 2 legs: + 310	3 position 3		OTB screen w 38.98"	
	13F3 grigio bromo	7 bronze color anodized	upcharge for 2 legs: + 595	4 position 4		OTC screen w 46.85"	
	13F4 black	8 natural anodized		5 position 5		OTD screen w 50.79"	
	13F6 blue fes	9 beige luxor matching	lacquered	7 position 7		OTE screen w 54.72"	
	13F7 verde comodoro	upcharge for 2 legs: + 595		8 position 8		OTF screen w 58.66"	
	13F8 beige luxor			9 position 9		OTG screen w 62.60"	
	13F9 rosso jaipur			4b) Grommet 2		OTH screen w 70.47"	
				0 no 2nd grommet		OTI screen w 78.35"	
0.71" veneer A	0.71" veneer B	3) Grommet type		1 position 1		OTJ screen w 86.22"	
18ES ash	18ME fossile oak	000 without grommets (skip 4)		3 position 3		OTK screen w 94.09"	
18NN walnut	18GE fumed oak	E diam. 2.36"	M Style 4	4 position 4		Upcharge fittings + 73	
18NM walnut mismatched	18TE teak	G diam. 3.15"	N Style 5	5 position 5			
18KE cherry	18ZE zebrano	H HUB (+)	O Style 6	7 position 7		6) position screen	
18EK European oak	18PL Santos Rosewood	I Go	X XXL	8 position 8		L left M central R right	
18EE black lacquered oak	18WE wenge	J Normal	Y Point	9 position 9		Price screen, see price list Screens	
		K Style 2	Z Top access				
1.06"/0.39" veneer A	1.06"/0.39" veneer B	L Style 3		Positions, see p.111			
27ES ash	27ME fossile oak			(+) only on 7, 8 or 9			
27NN walnut	27GE fumed oak						
27NM walnut mismatched	27TE teak						
27KE cherry	27ZE zebrano						
27EK European oak	27PL Santos Rosewood						
27EE black lacquered oak	27WE wenge						

Code example: H1414B13F44X800000 + H1414M13F44X800000 + H1414E13F44X800000 = 17.205

H₂O

Benches/meeting tables, d 62.99"

List prices

	Code	Melamine	Fenix hpl	Veneer A		Veneer B		
		0.71"	0.51"	0.71"	chamf.	0.71"	chamf.	
A bench is formed by at least 1 start module + 1 end module. One or more connecting modules can be added.								
62.99" deep								
Start module								
	w 55.12" x d 62.99"	H1416B *	5.480	8.265	8.925	9.995	11.965	12.815
	w 62.99" x d 62.99"	H1616B *	5.600	-	9.540	10.750	12.890	13.840
	w 70.87" x d 62.99"	H1816B *	5.790	-	10.215	11.575	13.890	14.960
	w 78.74" x d 62.99"	H2016B *	5.910	-	10.800	12.335	14.810	16.025
	w 86.61" x d 62.99"	H2216B *	6.060	-	11.430	13.110	15.755	17.070
Connecting module								
	w 55.12" x d 62.99"	H1416M *	4.625	6.505	8.080	9.145	11.120	11.965
	w 62.99" x d 62.99"	H1616M *	4.745	-	8.680	9.895	12.040	12.985
	w 70.87" x d 62.99"	H1816M *	4.940	-	9.365	10.730	13.035	14.110
	w 78.74" x d 62.99"	H2016M *	5.065	-	9.945	11.480	13.965	15.180
	w 86.61" x d 62.99"	H2216M *	5.210	-	10.580	12.260	14.910	16.220
End module								
	w 55.12" x d 62.99"	H1416E *	3.090	4.990	6.545	7.615	9.585	10.435
	w 62.99" x d 62.99"	H1616E *	3.215	-	7.150	8.375	10.510	11.455
	w 70.87" x d 62.99"	H1816E *	3.410	-	7.835	9.195	11.500	12.580
	w 78.74" x d 62.99"	H2016E *	3.530	-	8.420	9.945	12.430	13.645
	w 86.61" x d 62.99"	H2216E *	3.680	-	9.050	10.730	13.375	14.690

With 1.06"/0.39" veneer tops, the adjacent edges are straight, the other edges are chamfered.

* FINISHES & CODES

1) Top		2) Legs		4) Grommet position		5) Fittings for built-in screen on 2 feet	
0.71" melamine	0.51" hpl Fenix	1 lily white lacquered	4) Grommet 1	<u>screen on 2 feet</u>			
1801 lily white	13F1 white	4 black lacquered	1 position 1	0000 no screen (skip 6)			
	13F2 beige Arizona	5 grey-green lacquered	3 position 3	OTA screen w 31.10"			
	13F3 grigio bromo	upcharge for 2 legs: + 310	4 position 4	OTB screen w 38.98"			
	13F4 black	7 bronze color anodized	5 position 5	OTC screen w 46.85"			
	13F6 blue fes	upcharge for 2 legs: + 595	7 position 7	OTD screen w 50.79"			
	13F7 verde comodoro	8 natural anodized	8 position 8	OTE screen w 54.72"			
	13F8 beige luxor	9 beige luxor matching	9 position 9	OTF screen w 58.66"			
	13F9 rosso jaipur	lacquered		OTG screen w 62.60"			
		upcharge for 2 legs: + 595	4b) Grommet 2	OTH screen w 70.47"			
0.71" veneer A	0.71" veneer B		0 no 2nd grommet	OTI screen w 78.35"			
18ES ash	18ME fossile oak	<u>3) Grommet type</u>	1 position 1	OTJ screen w 86.22"			
18NN walnut	18GE fumed oak	000 without grommets (skip 4)	3 position 3	Upcharge fittings + 73			
18NM walnut mismatched	18TE teak	E diam. 2.36" M Style 4	4 position 4				
18KE cherry	18ZE zebrano	G diam. 3.15" N Style 5	5 position 5	<u>6) position screen</u>			
18EK European oak	18PL Santos Rosewood	H HUB (+) O Style 6	7 position 7	L left M central R right			
18EE black lacquered oak	18WE wenge	I Go X XXL	8 position 8				
		J Normal Y Point	9 position 9	Price screen, see price list Screens			
		K Style 2 Z Top access					
1.06"/0.39" veneer A	1.06"/0.39" veneer B	L Style 3		Positions, see p.111			
27ES ash	27ME fossile oak			(+) only on 7, 8 or 9			
27NN walnut	27GE fumed oak						
27NM walnut mismatched	27TE teak	Upcharge per grommet cutout:					
27KE cherry	27ZE zebrano	+ 73					
27EK European oak	27PL Santos Rosewood	Grommet price, see price list Electrification					
27EE black lacquered oak	27WE wenge						

Code example: H1616B27GE7J790000 + H1616E27GE7J790000 = 26.485

H₂O

Benches/meeting tables, d 70.87"

List prices

Code	Melamine	Fenix hpl	Veneer A		Veneer B	
	0.71"	0.51"	0.71"	chamf.	0.71"	chamf.

A bench is formed by at least 1 start module + 1 end module. One or more connecting modules can be added.

70.87" deep

Start module



w 55.12" x d 70.87"	H1418B *	5.600	8.365	9.465	10.680	12.815	13.745
w 62.99" x d 70.87"	H1618B *	5.765	-	10.190	11.550	13.865	14.935
w 70.87" x d 70.87"	H1818B *	5.910	-	10.875	12.405	14.910	16.125
w 78.74" x d 70.87"	H2018B *	6.080	-	11.600	13.305	15.950	17.315
w 86.61" x d 70.87"	H2218B *	6.325	-	12.380	14.250	16.970	18.575

Connecting module



w 55.12" x d 70.87"	H1418M *	4.770	6.610	8.635	9.855	11.990	12.910
w 62.99" x d 70.87"	H1618M *	4.915	-	9.340	10.705	13.010	14.085
w 70.87" x d 70.87"	H1818M *	5.090	-	10.045	11.575	14.085	15.300
w 78.74" x d 70.87"	H2018M *	5.260	-	10.775	12.480	15.130	16.490
w 86.61" x d 70.87"	H2218M *	5.480	-	11.525	13.400	16.125	17.730

End module



w 55.12" x d 70.87"	H1418E *	2.985	5.420	7.035	8.250	10.385	11.305
w 62.99" x d 70.87"	H1618E *	3.150	-	7.760	9.120	11.430	12.505
w 70.87" x d 70.87"	H1818E *	3.285	-	8.445	9.970	12.480	13.695
w 78.74" x d 70.87"	H2018E *	3.440	-	9.170	10.875	13.525	14.885
w 86.61" x d 70.87"	H2218E *	3.670	-	9.945	11.820	14.540	16.150

With 1.06"/0.39" veneer tops, the adjacent edges are straight, the other edges are chamfered.

* FINISHES & CODES

1) Top		2) Legs		4) Grommet position		5) Fittings for built-in	
0.71" melamine	0.51" hpl Fenix	1 lily white lacquered	4a) Grommet 1	<u>screen on 2 feet</u>			
1801 lily white	13F1 white	4 black lacquered	1 position 1	0000 no screen (skip 6)			
	13F2 beige Arizona	5 grey-green lacquered	3 position 3	OTA screen w 31.10"			
	13F3 grigio bromo	upcharge for 2 legs: + 310	4 position 4	OTB screen w 38.98"			
	13F4 black	7 bronze color anodized	5 position 5	OTC screen w 46.85"			
	13F6 blue fes	upcharge for 2 legs: + 595	7 position 7	OTD screen w 50.79"			
	13F7 verde comodoro	8 natural anodized	8 position 8	OTE screen w 54.72"			
	13F8 beige luxor	9 beige luxor matching	9 position 9	OTF screen w 58.66"			
	13F9 rosso jaipur	lacquered		OTG screen w 62.60"			
		upcharge for 2 legs: + 595	4b) Grommet 2	OTH screen w 70.47"			
0.71" veneer A	0.71" veneer B		0 no 2nd grommet	OTI screen w 78.35"			
18ES ash	18ME fossile oak	3) <u>Grommet type</u>	1 position 1	OTJ screen w 86.22"			
18NN walnut	18GE fumed oak	000 without grommets (skip 4)	3 position 3	Upcharge fittings + 73			
18NM walnut mismatched	18TE teak	E diam. 2.36" M Style 4	4 position 4				
18KE cherry	18ZE zebrano	G diam. 3.15" N Style 5	5 position 5	<u>6) position screen</u>			
18EK European oak	18PL Santos Rosewood	H HUB (+) O Style 6	7 position 7	L left M central R right			
18EE black lacquered oak	18WE wenge	I Go X XXL	8 position 8				
		J Normal Y Point	9 position 9	Price screen, see price list Screens			
		K Style 2 Z Top access					
1.06"/0.39" veneer A	1.06"/0.39" veneer B	L Style 3		Positions, see p.111			
27ES ash	27ME fossile oak			(+) only on 7, 8 or 9			
27NN walnut	27GE fumed oak	Upcharge per grommet cutout:					
27NM walnut mismatched	27TE teak	+ 73					
27KE cherry	27ZE zebrano	Grommet price, see price list Electrification					
27EK European oak	27PL Santos Rosewood						
27EE black lacquered oak	27WE wenge						

Code example: H1818B18018H800THM + H1818E18018H800THM = 9.342

H₂O

3. Standing height, h 40.55" - 43.70"

List prices

Tops in melamine, Fenix hpl or veneer

Code	Melamine		Fenix hpl		Veneer A		Veneer B	
	0.71"		0.51"		0.71"	chamf.	0.71"	chamf.

The legs are only available in powder coat lily white, black or grey-green.

31.50" deep

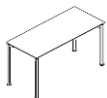

w 31.50" x d 31.50"	H0808H *	3.550	4.215	4.495	4.785	5.725	5.935
w 55.12" x d 31.50"	H1408H *	3.810	4.810	5.430	5.950	7.265	7.655
w 62.99" x d 31.50"	H1608H *	3.905	5.005	5.755	6.345	7.780	8.210
w 70.87" x d 31.50"	H1808H *	3.955	5.155	6.025	6.700	8.235	8.745
w 78.74" x d 31.50"	H2008H *	4.030	5.340	6.325	7.070	8.745	9.275
w 86.61" x d 31.50"	H2208H *	4.125	5.560	6.655	7.460	9.260	9.865

39.37" deep

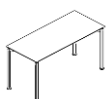

w 39.37" x d 39.37"	H1010H *	3.710	4.630	5.160	5.625	6.825	7.165
w 55.12" x d 39.37"	H1410H *	3.905	5.090	5.910	6.555	8.015	8.505
w 62.99" x d 39.37"	H1610H *	3.980	5.300	6.280	6.995	8.600	9.165
w 70.87" x d 39.37"	H1810H *	4.055	5.530	6.630	7.460	9.190	9.790
w 78.74" x d 39.37"	H2010H *	4.150	5.840	7.020	7.890	9.765	10.475
w 86.61" x d 39.37"	H2210H *	4.300	6.150	7.705	8.745	9.260	9.865

* FINISHES & CODES



1) Top		2) Legs		4) Grommet position		5) Fittings for screen	
0.71" melamine	0.51" hpl Fenix	1 lily white lacquered		4a) Grommet 1	attached to table top		
1801 lily white	13F1 white	4 black lacquered		1 position 1	0000 no screen (skip 6)		
	13F2 beige Arizona	5 grey-green lacquered		2 position 2	OVA screen w 31.10"		
	13F3 grigio bromo	upcharge for 4 legs: + 620		3 position 3	OVB screen w 38.98"		
	13F4 black	9 beige luxor matching		4 position 4	OVC screen w 46.85"		
	13F6 blue fes	lacquered		5 position 5	OVD screen w 50.79"		
	13F7 verde comodoro	upcharge for 4 legs: + 1.190		6 position 6	OVE screen w 54.72"		
	13F8 beige luxor			7 position 7 (++)	OVF screen w 58.66"		
	13F9 rosso jaipur			8 position 8 (++)	OVG screen w 62.60"		
				9 position 9 (++)	OVH screen w 70.47"		
0.71" veneer A	0.71" veneer B	3) Grommet type			OVI screen w 78.35"		
18ES ash	18ME fossile oak	000 without grommets (skip 4)		4b) Grommet 2	OVJ screen w 86.22"		
18NN walnut	18GE fumed oak	E diam. 2.36"	M Style 4	0 no 2nd grommet	OVK screen w 94.09"		
18NM walnut mismatched	18TE teak	G diam. 3.15"	N Style 5	1 position 1	OVL screen w 101.97"		
18KE cherry	18ZE zebrano	H HUB (+)	O Style 6	2 position 2	Upcharge fittings + 73		
18EK European oak	18PL Santos Rosewood	I Go	X XXL	3 position 3			
18EE black lacquered oak	18WE wenge	J Normal	Y Point	4 position 4	6) position screen		
		K Style 2	Z Top access	5 position 5	L left M central R right		
		L Style 3		6 position 6			
1.06"/0.39" veneer A	1.06"/0.39" veneer B	Upcharge per grommet cutout:		7 position 7 (++)	Price screen, see		
27ES ash	27ME fossile oak	+ 73		8 position 8 (++)	price list Screens		
27NN walnut	27GE fumed oak	Grommet price, see price list		9 position 9 (++)			
27NM walnut mismatched	27TE teak	Electrification		Positions, see p.111			
27KE cherry	27ZE zebrano			(+) only on 7, 8 or 9			
27EK European oak	27PL Santos Rosewood			(++) see exclusions p.111			
27EE black lacquered oak	27WE wenge						

Code example: H1608H13F750000000 = 5.625

H2O

4. Executive tables with leather top

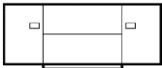
1.2. Top in leather + accessories in leather

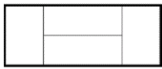
		Code	List prices
With 2 grommets type Normal and underdesk high gloss lacquered drawer			
	w 94.49" x d 39.37" w 105.51" x d 47.24"	H2410SL1 * 4J26000 H2712SL1 * 4J26000	27.990 31.055
With 2 grommets, type Normal, without underdesk drawer			
	w 94.49" x d 39.37" w 105.51" x d 47.24"	H2410SLO * 4J26000 H2712SLO * 4J26000	22.400 25.430
Without grommets, without underdesk drawer			
	w 55.12" x d 55.12" w 94.49" x d 39.37" w 105.51" x d 47.24"	H1414SLO * 4000000 H2410SLO * 4000000 H2712SLO * 4000000	19.890 21.325 24.340

* FINISHES & CODES

Leather

LG grey-green leather

LR red leather

The grey-green and red leather are of the highest quality, handpicked at the tanner by Bulo

Grey-green leather top:

Black edge profile and base, the underdesk drawer in red high gloss lacquer

2 Normal grommets with black frame and grey-green leather cover, on positions 2 and 6

Red leather top:

Black edge profile and base, the underdesk drawer in black high gloss lacquer



2 Normal grommets with black lacquered frame and red leather cover, on positions 2 and 6

The underdesk drawer houses a small round station clock

Code example: H2712SL1LG4J26000 = 31.055

H2O

5. Accessories

		Code	List prices
5.1. Screens with 2 metal profiles or built-in through the top			
See price list Screens			
Make sure the H2O table or bench is specified with fittings for the required screen.			
5.2. Horizontal cable management			
5.2.1. Cable nets for H2O desks 31.50" deep			
	Desk w 55.12" or wider. Cable net w 35.43" x d 16.81"	H2+KN0904 *	330
	Desk w 78.74" or wider. Cable net w 59.06" x d 16.81"	H2+KN1504 *	335
5.2.2. Cable nets for H2O desks 39.37" deep			
	Desk w 55.12" or wider. Cable net w 35.43" x d 24.69"	H2+KN0906 *	345
	Desk w 78.74" or wider. Cable net w 59.06" x d 24.69"	H2+KN1506 *	360
5.2.3. Cable nets for H2O desks 47.24" deep			
	Desk w 78.74" or wider. Cable net w 59.06" x d 32.56"	H2+KN1508 *	385
5.2.4. Cable nets for H2O bench module (suitable for all module depths) and for H2O table 51.18" deep or deeper			
	Module w 55.12" or wider. Cable net w 35.43" x d 24.69"	H2+KN0906 *	345
	Module w 78.74" or wider. Cable net w 59.06" x d 24.69"	H2+KN1506 *	360
5.2.5. Cable clamps			
	Single cable clamp 4.13", grey	ELCKK02	NET PRICES 22
	Double cable clamp 8.27", black	ELCKK04	22
5.3. Vertical cable management			
	Cable spine with foot, grey	H2+SLFR	List prices 255
5.4. Grommets			
See price list Electrification			

* FINISHES & CODES

Cable net finish

- 04 black RAL 9005
- 08 grey RAL 7037

H2O

6. Colors and materials

MELAMINE



Lily white

FENIX HPL

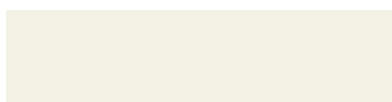

Lily white 0029

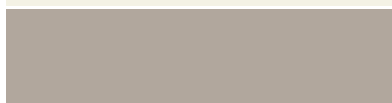

Beige Arizona 0748

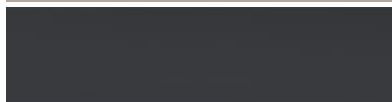

Grigio bromo 0724



Black 0720



Blu fes 0754



Verde comodoro 0750



Beige luxor 0719



Rosso jaipur 0751

LEGS IN SOLID ALUMINIUM

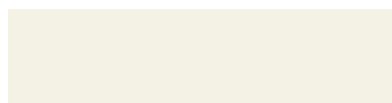

Lily white lacquered



Black lacquered



Natural anodized



Bronze color anodized



Grey-green lacquered
NCS S7005-B80G



Beige luxor matching
lacquered
NCS S2010-Y30R

VENEER CATEGORY A



Ash



Walnut



Walnut mismatched



Cherry



European oak



Black lacquered
European oak

VENEER CATEGORY B



Fossile oak



Fumed oak

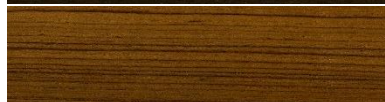

Teak



Zebrano



Santos rose wood



Wenge

Digital or paper printing is not binding

Kei

by BuloDesign



Kei

by BuloDesign

Pebbles on the beach or river banks are irregular and random yet they fit and belong together. This is the concept that "inspired" the modular system Kei. The elements can be configured in a myriad of different ways and allows for easy re-configuration as it's free of the grid planning systems. Kei creates an organic landscape when grouped together or used as an individual shape.

TABLE TOP FINISHES

- Always with fillet edging
 - mdf powdercoated lily white, 0.98" thick
 - oak veneer, 1.02" thick: natural, black lacquered or red lacquered
- The fillet edging can not be veneered all the way round.
The lacquered mdf will be visible in the curve of the lower edging.

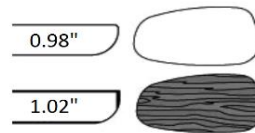

BASE

Always lacquered in coffee bean color

DESKS

Dimensions

- ± w 66.93" x d 34.84"
- ± w 78.74" x d 34.84"
- ± w 90.55" x d 39.37"

Heights

- Height adjustable with lever 24.41" - 33.46"
- Fixed height 29.53"

Grommets

- felt pod with porcelain cover on the small side of the desk
 - * white porcelain cover with lily white powdercoated tops
 - * black porcelain cover with veneer tops
- round hole, centrally positioned on the visitor's side
 - * deepest side of the desk on the right hand side
 - * deepest side of the desk on the left hand side

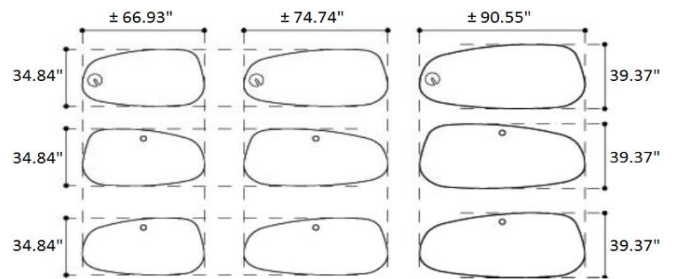

Base on adjustable feet

All Kei desks come with 3 underdesk cable clamps as a standard

SIDE TABLES

Tops

- pebble shaped, ± 33.46" x 33.46"
- round, diam. 29.53"

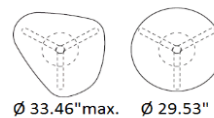

Heights

- 18.11", coffee table height
- 22.05", coffee table height
- 29.53", desk height
- 43.31", standing height
- 29.13"-43.31" height adjustable with gas lift

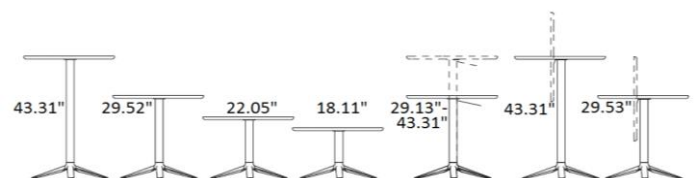

Flip tops

- 29.53", desk height
- 43.31", standing height

Base on adjustable feet or on castors

Kei

by BuloDesign

MEETING TABLES WITH ORGANIC SHAPED TOP

Dimensions: ± 58.19" x 48.50" x h 29.53"
Its unique shape offers various configurations.

Grommets

- without grommet
- with grommet and porcelain cover. Grommet with metal bracket to hold 2 socket outlets of each 2 modules
 - * white porcelain cover with lily white powdercoated tops
 - * black porcelain cover with veneer tops

The central column base guides the cables to the floor and is covered with black 3D knitted tricot fabric

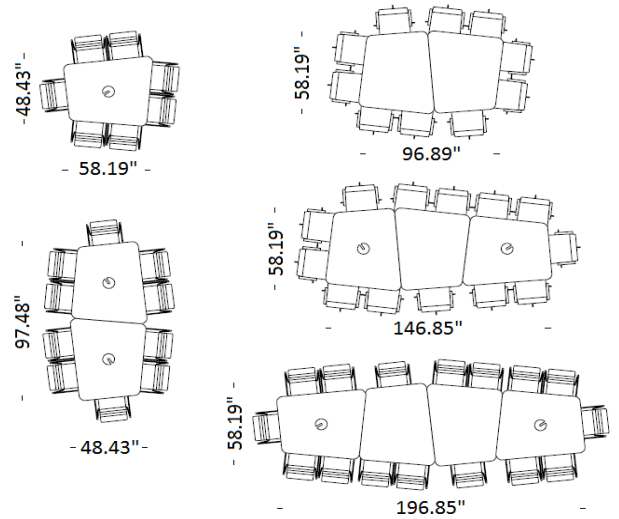

RECTANGULAR MEETING TABLES

Fixed top or flip top

Dimensions

- ± w 66.93" x d 29.53"
- ± w 78.74" x d 29.53"
- ± w 90.55" x d 29.53"

Heights

- fixed top, base on adjustable feet: h 29.53"
- fixed top, base on castors: h 30.71"
- flip top, base on adjustable feet: h 28.35"
- flip top, base on castors: h 29.53"

Base

- on adjustable feet or on castors
- flip top tables come with a coffee bean lacquered crossbeam
- the flip top mechanism can be operated with one hand

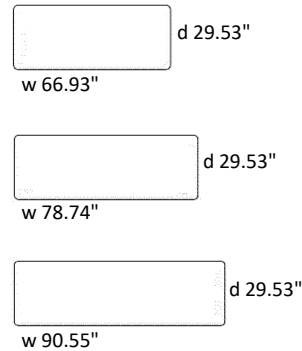

STANDING HEIGHT MEETING TABLES

Fixed top, pebble shaped

Dimensions

- ± w 66.93" x d 34.84"
- ± w 78.74" x d 34.84"
- ± w 90.55" x d 39.37"

Fixed height: 43.31"

Base on adjustable feet

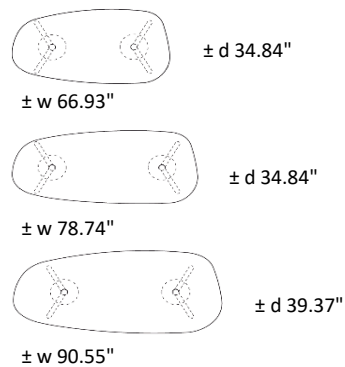





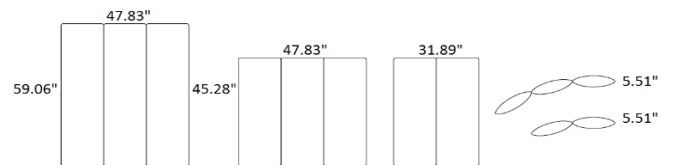

SCREENS

Light core in environmentally friendly EEP (expanded polypropylene) covered in 3D knitted tricot fabric
Easy to move visual separation, non acoustic

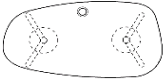
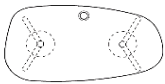

Kei

1. Desks

		Code	Powdercoat	List prices	
				Veneer	
Base coffee bean lacquered					
w 66.93" x d 34.84"					
	felt pod with porcelain cover	fixed height height adjustable	KEIWTFI17 * RO06 KEIWTHM17 * RO06	2.970 4.450	5.575 7.060
	round cutout with deepest side desk at the right	fixed height height adjustable	KEIBTRFI17 * RO06 KEIBTRHM17 * RO06	2.445 3.850	4.950 6.350
	round cutout with deepest side desk at the left	fixed height height adjustable	KEIBTLFI17 * RO06 KEIBTLHM17 * RO06	2.445 3.850	4.950 6.350
w 78.74" x d 34.84"					
	felt pod with porcelain cover	fixed height height adjustable	KEIWTFI20 * RO06 KEIWTHM20 * RO06	3.825 5.220	6.350 7.755
	round cutout with deepest side desk at the right	fixed height height adjustable	KEIBTRFI20 * RO06 KEIBTRHM20 * RO06	3.115 4.520	5.650 7.045
	round cutout with deepest side desk at the left	fixed height height adjustable	KEIBTLFI20 * RO06 KEIBTLHM20 * RO06	3.115 4.520	5.650 7.045
w 90.55" x d 39.37"					
	felt pod with porcelain cover	fixed height height adjustable	KEIWTFI23 * RO06 KEIWTHM23 * RO06	3.850 5.265	6.850 8.275
	round cutout with deepest side desk at the right	fixed height height adjustable	KEIBTRFI23 * RO06 KEIBTRHM23 * RO06	3.260 4.695	6.270 7.705
	round cutout with deepest side desk at the left	fixed height height adjustable	KEIBTLFI23 * RO06 KEIBTLHM23 * RO06	3.260 4.695	6.270 7.705

FINISHES & CODES









* Finish top

- 01 powdercoated lily white**
- EK oak veneer, natural
- ER oak veneer, red lacquered
- EE oak veneer, black lacquered

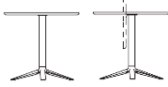
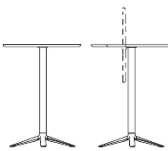
Code example: KEIWTHM2001RO06 = 5.220

Kei

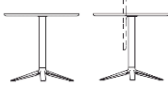
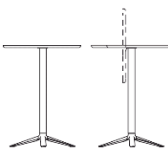
2. Side tables

		Code	Powdercoat	Veneer	List prices
Base coffee bean lacquered					
	Organic shaped top, ± 33.46" x 33.46"				
	fixed height 18.11"	fixed top	KEISTFI04 * RO06 **	1.235	2.425
	fixed height 22.05"	fixed top	KEISTFI05 * RO06 **	1.235	2.425
	fixed height 29.53"	fixed top flip top	KEISTFI07 * RO06 ** KEISFFI07 * RO06 **	1.260 1.420	2.465 2.625
	fixed height 43.31"	fixed top flip top	KEISTFI11 * RO06 ** KEISFFI11 * RO06 **	1.305 1.470	2.515 2.675
	height adjustable 29.13"-43.31" with gas lift	fixed top	KEI STHM * RO06 **	2.325	3.530
	Round top, diam. 29.53"				
	fixed height 18.11"	fixed top	KEIROTFI04 * RO06 **	1.235	2.425
	fixed height 22.05"	fixed top	KEIROTFI05 * RO06 **	1.235	2.425
	fixed height 29.53"	fixed top flip top	KEIROTFI07 * RO06 ** KEIROFFI07 * RO06 **	1.260 1.420	2.465 2.625
	fixed height 43.31"	fixed top flip top	KEIROTFI11 * RO06 ** KEIROFFI11 * RO06 **	1.305 1.470	2.515 2.675
	height adjustable 29.13"-43.31" with gas lift	fixed top	KEI ROTHM * RO06 **	2.325	3.530

FINISHES & CODES

* Finish top

- 01 powdercoated lily white
- EK oak veneer, natural**
- ER oak veneer, red lacquered
- EE oak veneer, black lacquered







** Castors or adjustable feet

- D adjustable feet**
- W castors
- upcharge for castors: + 77

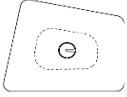
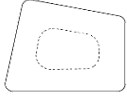
Code example: KEISTFI11EKRO06D = 2.515

Kei

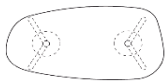
3. Meeting tables

		Code	Powdercoat	Veneer	List prices
Organic shaped top					
Central column base covered in black 3D knitec tricot fabric					
Dimensions: ± 58.19" x 48.50" x h 29.53"					
	with grommet with porcelain cover	KEI MT * ROELZW	5.065	6.875	
	without grommet	KEI MT * RO00ZW	4.720	6.530	
Rectangular top, h 29.53"					
Flip top table. Mechanism can be operated with one hand.					
Base coffee bean lacquered					
	w 66.93" x d 29.53"	fixed top flip top	KEI RET1707 * RO06 ** KEI REF1707 * RO06 **	2.945 3.270	5.455 5.780
	w 78.74" x d 29.53"	fixed top flip top	KEI RET2007 * RO06 ** KEI REF2007 * RO06 **	3.350 3.680	5.880 6.205
	w 90.55" x d 29.53"	fixed top flip top	KEI RET2307 * RO06 ** KEI REF2307 * RO06 **	3.475 3.800	6.475 6.800
Standing height tables, h 43.31"					
Base in coffee bean color on glides, fixed height					
No crossbeam. Top without cutout					
	w 66.93" x d 34.84"		KEIHTFI17 * 06D	2.735	5.235
	w 78.74" x d 34.84"		KEIHTFI20 * 06D	3.400	5.935
	w 90.55" x d 39.37"		KEIHTFI23 * 06D	3.550	6.555

FINISHES & CODES

* Finish top

01 powdercoated lily white
 EK oak veneer, natural
 ER oak veneer, red lacquered
 EE oak veneer, black lacquered

** Castors or adjustable feet



D adjustable feet
W castors
upcharge for castors: + 77

Code example: KEI REP200701RO06W = 3.757

Kei

4. Accessories

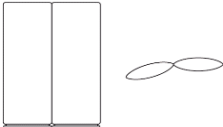
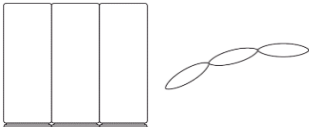
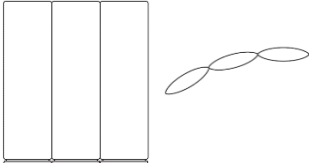
List prices

		Code	
Screens			
	2 elements, w 31.89" x d 5.51" x h 45.28"	KEI SC2H3ST *	865
	3 elements, w 47.83" x d 5.51" x h 45.28"	KEI SC3H3ST *	1.250
	3 elements, w 47.83" x d 5.51" x h 59.06"	KEI SC3H4ST *	2.570
Vertical cable duct			
	vertical cable duct in black fabric with zipper	KEI KOUSU1	215
Bracket for socket outlet			
	To mount in the felt pod Steel, powdercoated in coffee bean color Has a cutout to take a built-in socket outlet with 2 modules Socket outlet: see price list Electrification	KEI FXPP06	85

FINISHES & CODES

* 3D knitted tricot cover for screens

- 06 Bulo-red, approx. RAL3020
- 10 Black, approx. RAL 9005
- CR Combination of 2 different shades of red, approx. RAL 3020 and RAL 3031

Code example: KEI SC3H3ST06 = 1.250

Kei

5. Colors and materials

TOP

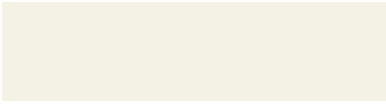

Powdercoated
lily white



European oak veneer
natural



European oak veneer
black lacquered



European oak veneer
red lacquered

BASE

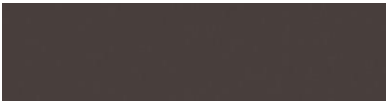

Coffee bean color
lacquered

PORCELAIN TRAY



White



Black

Normal

by Jean Nouvel



Normal

by Jean Nouvel

Normal is Jean Nouvel's contemporary rendition of the classic executive office furniture of the past. The proportions are bold and architectural and the forms are clean and pure.

TECHNICAL INFORMATION

DESK

A desk consists out of 3 elements: a top supported by a pedestal on one side and by a credenza on the other side. Which one on the left and which one on the right can be chosen before production. The top is connected to both volumes by means of 2 star-shaped elements. The credenza is turned 90° and has 2 lateral doors.

Total dimensions of the desk: w 120.71" x d 53.07" x h 29.53"

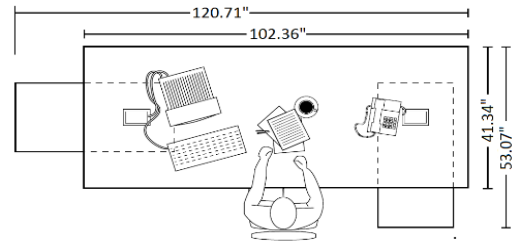

Work top

Dimensions: w 102.36" x d 41.34" x h 1.77"

The edges of the 1.77" thick work top are made out of strips in solid wood.

Two grommets on strategic places (for cable management) have covers in the same finish as the top and an anthracite lacquered frame. The star-shaped elements guide cables from the electrification space at the back of the pedestal, through the integrated horizontal cable duct in the underside of the desk top, to the credenza.

Pedestal

Dimensions: w 20.20" x d 42.44" x h 22.83". The borders are in solid wood.

The pedestal is not lockable.

The back compartment of the pedestal functions as a cable space and has a door.

The front of the pedestal has various possible lay-outs:

- 1 hinged door with glass shelf
- 1 pull-out shelf and 2 drawers
- 1 pull-out shelf and 1 A4 filing drawer
- 1 drawer and 1 A4 filing drawer

Credenza

Dimensions: w 42.44" x d 20.20" x h 22.83". The borders are in solid wood and have glass or veneer side panels.

Each compartment is equipped with a glass shelf.

Front layout: double door, centrally hinged, both lockable with cylinder lock.

Finishes

EK European oak veneer

- top in oak veneer with solid ash edges
- pedestal and credenza with carcass in oak veneer and frames in solid oak
- credenza with glass shelves/glass side panels in blue glass

EZ black lacquered ash veneer

- top in black lacquered ash veneer with black lacquered solid ash edges
- pedestal and credenza with carcass in black lacquered ash veneer and frames in black lacquered solid ash
- credenza with glass shelves/glass side panels in opal glass

SW satin walnut veneer

- top in satin walnut veneer with solid ash edges
- pedestal and credenza with carcass in satin walnut veneer and frames in solid ash
- credenza with glass shelves/glass side panels in red glass

F1 lily white Fenix HPL / F4 black Fenix HPL

- top in Fenix HPL with solid ash edges
- pedestal and credenza with carcass in Fenix HPL and frames in solid ash
- credenza with glass shelves/glass side panels in opal glass

Normal

by Jean Nouvel

STORAGE UNITS

4 types

Low storage unit d 20.20" x h 32.87", with 4 doors w 71.30" or with 6 doors w 106.50"
High storage units d 20.20" x h 63.11", with 4 doors w 71.30" or with 6 doors w 106.50"

Lay-out

A storage unit with 4 doors has a central compartment with lockable double hinged doors and on both ends a half compartment with a hinged door both at the front and at the back side of the storage unit.
A storage unit with 6 doors has 2 central compartments with lockable double hinged doors and on both ends a half compartment with a hinged door both at the front and at the back side of the storage unit.
The half compartments each have 1 (low unit) or 2 (high unit) glass shelves.
The doors of the half compartments are not lockable.
The back of the storage unit is identical to the front so the storage unit can be used freestanding in a room. At the back side the half compartments have a door, the central compartments have a fixed back. The sides have a frame in solid wood and a panel in HPL, veneer or in colored glass.

Finish

EK European oak veneer

- carcass in oak veneer with solid oak edges
- interior central compartment(s) in lily white melamine
- half compartments with blue glass shelves
- half compartments with either oak veneer side panels or blue glass side panels

EZ black lacquered ash veneer

- carcass in black lacquered ash veneer with black lacquered solid ash edges
- interior central compartment(s) in black melamine
- half compartments with opal glass shelves
- half compartments with either black lacquered ash veneer side panels or opal glass side panels

SW satin walnut veneer

- carcass in satin walnut veneer with solid ash edges
- interior central compartment(s) in black melamine
- half compartments with red glass shelves
- half compartments with either black lacquered ash veneer side panels or red glass side panels

F1 lily white Fenix HPL / F4 black Fenix HPL

- carcass in Fenix HPL with solid ash edges
- white Fenix HPL with interior central compartment(s) in lily white melamine
- black Fenix HPL with interior central compartment(s) in black melamine
- half compartments with opal glass shelves
- half compartments with either Fenix HPL side panels or opal glass side panels

FENIX HPL

FENIX NTM® is a super opaque nanotech material. It combines elegant aesthetic solutions with state-of-the-art technological performance. The external surface of FENIX NTM® involves the use of nanotechnology that allows thermal healing of superficial micro-scratches. FENIX NTM® has low light reflectivity, is anti-fingerprint and features a very pleasant soft touch. It is highly resistant to scratches, abrasion, rubbing and dry heat. It significantly reduces the bacterial load making its surface hygienic and easy to clean. It is also liquid repellent and mould-proof.

Normal

1. Desks

	Credenza with glass side panels		Credenza with veneer or HPL side panels	
	Pedestal at the right	Pedestal at the left	Pedestal at the right	Pedestal at the left
Layout pedestal				
door	codes: JNBUDB01BL01 * GL	JNBUBL01DB01 * GL	JNBUDB02BL01 * VP	JNBUBL01DB02 * VP
pull-out shelf + 2 drawers	codes: JNBUDB01BL02 * GL	JNBUBL02DB01 * GL	JNBUDB02BL02 * VP	JNBUBL02DB02 * VP
pull-out shelf + filing drawer	codes: JNBUDB01BL03 * GL	JNBUBL03DB01 * GL	JNBUDB02BL03 * VP	JNBUBL03DB02 * VP
drawer + filing drawer	codes: JNBUDB01BL04 * GL	JNBUBL04DB01 * GL	JNBUDB02BL04 * VP	JNBUBL04DB02 * VP

List prices
29.205
32.865

All above desks in Fenix HPL
All above desks in oak, satin walnut or black lacquered ash veneer

Power socket for Normal grommet, see price list Electrification

* FINISHES & CODES

Fenix HPL

F1 lily white
F4 black

Veneer

EK European oak veneer
EZ black lacquered ash veneer
SW satin walnut veneer





Standard glass colors

EKGL European oak veneer -> blue glass
EZGL black lacquered ash veneer -> opal glass
SWGL satin walnut veneer -> red glass
F1GL white Fenix hpl -> opal glass
F4GL black Fenix hpl -> opal glass

Code example: JNBUDB01BL01SWGL = 32.865

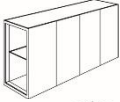
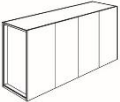
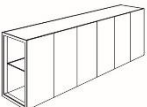
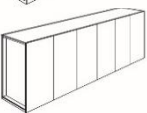
Normal

2. Storage units

	Carcass	Side panels	Code	List prices
2.1. Low storage units, 4 doors, w 71.30" x d 20.20" x h 32.87"				
	Fenix HPL veneer	opal glass glass	JNK08D4 * GL JNK08D4 ** GL	11.550 15.520
	Fenix HPL veneer	Fenix HPL veneer	JNK08D4 * VP JNK08D4 ** VP	10.750 15.260
				
2.2. Low storage units, 6 doors, w 106.50" x d 20.20" x h 32.87"				
	Fenix HPL veneer	opal glass glass	JNK08D6 * GL JNK08D6 ** GL	15.710 21.420
	Fenix HPL veneer	Fenix HPL veneer	JNK08D6 * VP JNK08D6 ** VP	14.935 21.190
				
2.3. High storage units, 4 doors, w 71.30" x d 20.20" x h 63.11"				
	Fenix HPL veneer	opal glass glass	JNK15D4 * GL JNK15D4 ** GL	18.120 22.800
	Fenix HPL veneer	Fenix HPL veneer	JNK15D4 * VP JNK15D4 ** VP	16.090 23.835
				
2.4. High storage units, 6 doors, w 106.50" x d 20.20" x h 63.11"				
	Fenix HPL veneer	opal glass glass	JNK15D6 * GL JNK15D6 ** GL	24.020 33.760
	Fenix HPL veneer	Fenix HPL veneer	JNK15D6 * VP JNK15D6 ** VP	21.990 32.765
				

FINISHES & CODES

* Fenix HPL

F1 lily white
F4 black

** Veneer

EK European oak veneer
EZ black lacquered ash veneer
SW satin walnut veneer

Standard glass colors

EKGL European oak veneer -> blue glass
EZGL black lacquered ash veneer -> opal glass
SWGL satin walnut veneer -> red glass
F1GL white Fenix hpl -> opal glass
F4GL black Fenix hpl -> opal glass

Code example: JNK08D6EKGL = 21.420

Normal

3. Colors and materials

FENIX HPL



lily white



black

VENEER



oak

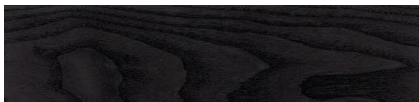

black lacquered ash



satin walnut

GLASS



blue

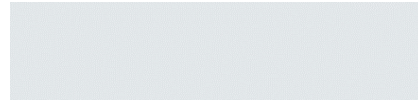

opal



red

SB55

by Stéphane Beel



SB55

by Stéphane Beel

...it's all about the legs he said, and she made another twist...
 SB55 is a table collection designed by Belgian architect Stéphane Beel.
 The design focuses on the V-shaped trestle structure in solid wood

TOPS

0.98" thick chipboard finished in melamine or Fenix hpl, with black abs edging
 0.94" veneer on mdf with matching edges

BASE

2V-legs and 5V-legs in solid wood: black lacquered ash, walnut color stained ash or solid natural oak

FENIX HPL

FENIX NTM® is a super opaque nanotech material that combines elegant aesthetic solutions with state-of-the-art technological performance. With low light reflectivity, its surface is extremely opaque, anti-fingerprint and features a very pleasant soft touch. Thanks to the use of nanotechnologies, FENIX NTM thermally heals any superficial micro-scratches. In addition, FENIX NTM® is highly resistant to scratches, abrasion, rubbing and dry heat. It also withstands impacts, reduces significantly the bacterial load making its surface hygienic and easy to clean. It is also liquid repellent and mould-proof. FENIX NTM® is only available for tops with a maximum depth of 59.06"

GROMMET POSITIONS

To ensure the correct cutout is made in the top, the type of grommet and its position must be indicated with the SB55 table.
 The grommet itself has to be ordered separately, see price list Electrification.
 The below views are top views and seen from the user's side.

1) SB55 table 31.50" or 35.43" deep

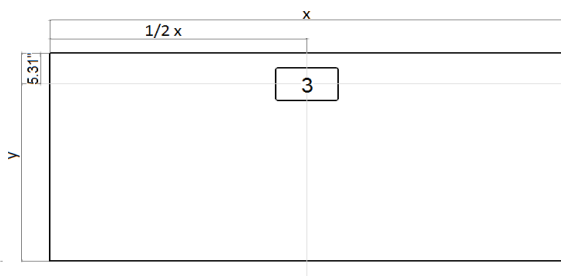

Grommet	Position 3	Position 7, 8, 9	Position 8
Diam. 2.36"	✓	✓	
Diam. 3.15"	✓	✓	
Go	✓	✓	
Hub E3			✓
Hub EL			✓
Normal	✓	✓	
Point	✓	✓	
Style	✓ (*)	✓	
Top Access	✓	✓	
XXL	✓	✓	

(*) 'Style' grommets require 8.27" between 2 opposite cutouts

2) SB55 table 59.06" deep

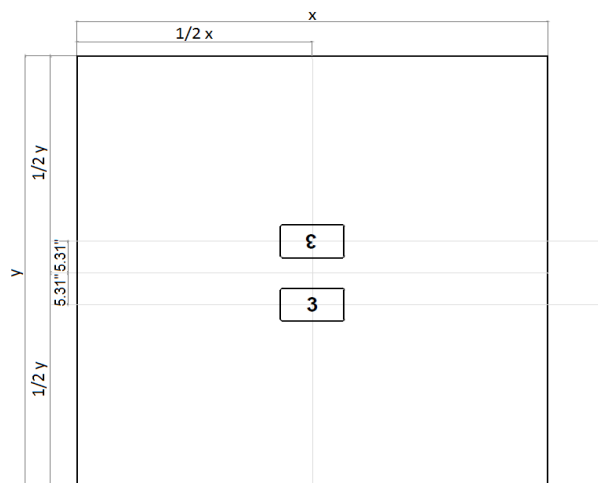
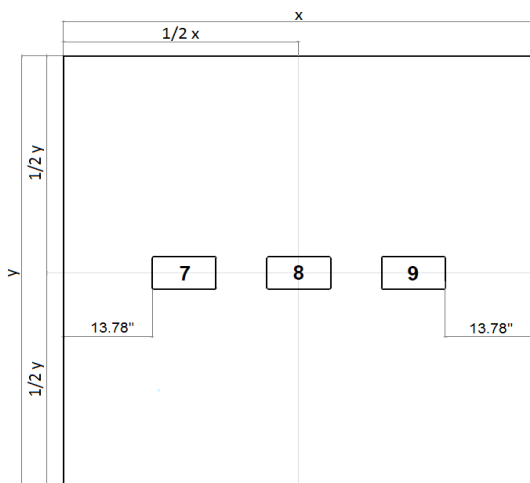

SB55

by Stéphane Beel

3) SB55 oval and elliptical tables

a) Position 8: central cutout in each top, positioned between the legs

Grommet	Position 8
Diam. 2.36"	✓
Diam. 3.15"	✓
Go	✓
Hub E3	✓
Hub EL	✓
Normal	✓
Point	✓
Style	✓
Top Access	✓
XXL	✓

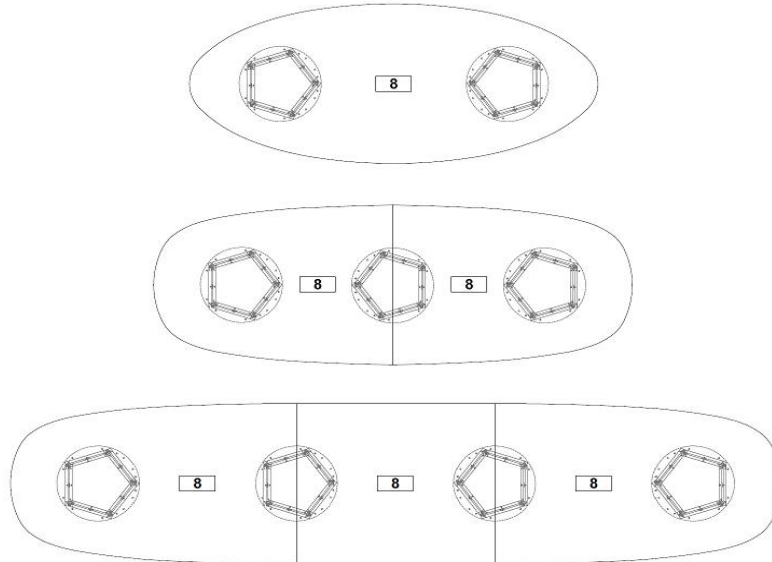

b) Position 9: central cutout above each leg

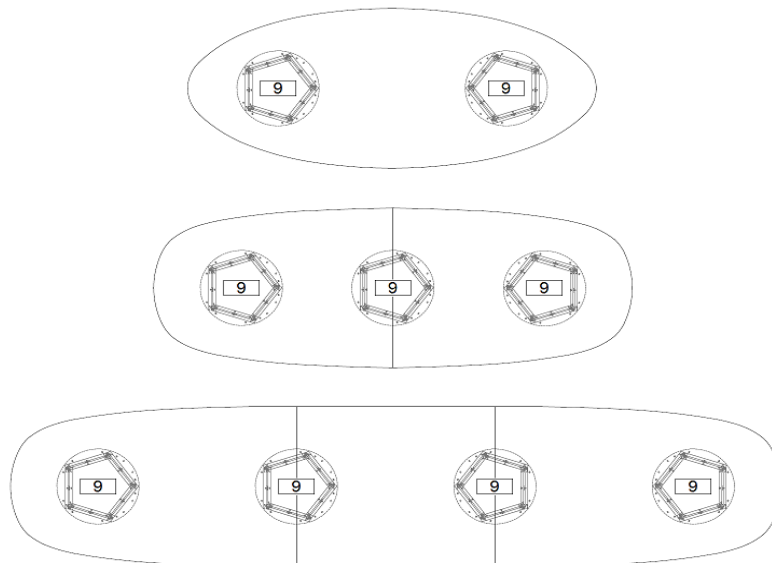

Grommet	Position 9
Diam. 2.36"	✓
Diam. 3.15"	✓
Go	✓
Hub E3	
Hub EL	
Normal	✓
Point	✓
Style	✓
Top Access	✓
XXL	✓



SB55

1. Individual and double tables

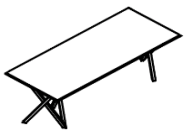
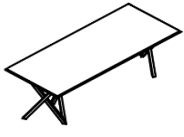
h 29.13"

			Melamine 0.98"	Fenix hpl 0.98"	Veneer A 0.94"	Veneer B 0.94"	List prices
		Code					
1.1. Individual table							
31.50" deep							
	w 62.99" x d 31.50"	SBS1608 *	1.550	1.990	2.450	3.215	
	w 70.87" x d 31.50"	SBS1808 *	1.615	2.070	2.550	3.340	
	w 78.74" x d 31.50"	SBS2008 *	1.665	2.135	2.630	3.450	
	w 94.49" x d 31.50"	SBS2408 *	1.845	2.380	2.925	3.835	
35.43" deep							
	w 62.99" x d 35.43"	SBS1609 *	1.605	2.055	2.530	3.315	
	w 70.87" x d 35.43"	SBS1809 *	1.665	2.135	2.630	3.450	
	w 78.74" x d 35.43"	SBS2009 *	1.720	2.205	2.730	3.575	
	w 94.49" x d 35.43"	SBS2409 *	1.865	2.450	2.945	3.865	
2.2. Double table							
59.06" deep							
	w 62.99" x d 59.06"	SBS1615 *	2.595	4.140	5.095	6.680	
	w 70.87" x d 59.06"	SBS1815 *	2.700	4.315	5.305	6.960	
	w 78.74" x d 59.06"	SBS2015 *	2.800	4.485	5.520	7.230	

* FINISHES & CODES

1) Top		For individual table		For double table	
		3) Grommet, on position 3		3) Grommet	
0.98" melamine	0.98" hpl Fenix	00 without grommet		00 without grommets (skip 4)	
01 lily white, with matching pvc edging	with black edging	E3 diam. 2.36"	M3 Style 4	E diam. 2.36"	M Style 4
18 lily white with black pvc edging	F1 white	G3 diam. 3.15"	N3 Style 5	G diam. 3.15"	N Style 5
	F2 beige Arizona	I3 Go	O3 Style 6	H HUB (+)	O Style 6
	F3 grigio bromo	J3 Normal	Y3 Point	I Go	X XXL
	F4 black	K3 Style 2	Z3 Top access	J Normal	Y Point
	F6 blue fes	L3 Style 3		K Style 2	Z Top access
	F7 verde comodo	Upcharge per grommet cutout:		L Style 3	
	F8 beige luxor	+ 73		Upcharge per grommet cutout:	
	F9 rosso jaipur			+ 73	
0.94" veneer A	0.94" veneer B			4) Positions grommet	
with matching edging	with matching edging			4a) Grommet 1	4b) Grommet 2
ES ash	ME fossile oak			3 position 3	0 no 2nd grommet
NN walnut	GE fumed oak			7 position 7	3 position 3
NM walnut mismatched	TE teak			8 position 8	7 position 7
KE cherry	ZE zebrano			9 position 9	8 position 8
EK European oak	PL Santos Rosewood				9 position 9
EE black lacquered oak	WE wenge				
2) Base in solid wood					
AB ash, black lacquered					
ON oak natural					
AW ash, walnut color stained					

Positions, see p.138

Price grommet, see price list Electrification

Code example: SBS1608F4AB00 = 1.990

SB55

2. Elliptical tables - executive/meeting tables

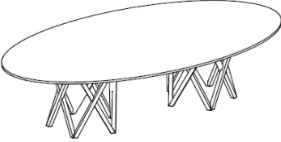
					List prices			
	h 29.13"				Melamine 0.98"	Fenix hpl 0.98"	Veneer A 0.94"	Veneer B 0.94"
		Code						
2.1. On 2 x 5V leg - top in 1 piece								
	w 108.26" x d 59.06" x h 29.13"	SB2715EL *	6.160	7.885	9.700	12.710		
	w 118.11" x d 59.06" x h 29.13"	SB3015EL *	6.490	8.310	10.225	13.395		
	w 127.95" x d 59.06" x h 29.13"	SB3215EL *	6.825	8.740	10.755	14.090		
	w 137.80" x d 59.06" x h 29.13"	SB3515EL *	7.155	9.160	11.270	14.765		

2.2. On 2 x 5V leg - top in 2 pieces with recessed supporting top in black mdf 0.98" thick

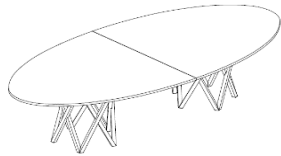

w 137.80" x d 59.06" x h 30.12"	SB3515E2 *	7.635	9.775	12.025	15.755
---------------------------------	------------	-------	-------	--------	--------

* FINISHES & CODES

1) Top		2) Base in solid wood		3) Grommet	
0.98" melamine	0.98" hpl Fenix	AB ash, black lacquered		00 without grommets (skip 4)	
01 lily white, with matching pvc edging	with black edging	ON natural oak		E diam. 2.36"	M Style 4
18 lily white with black pvc edging	F1 white	AW ash, walnut color stained		G diam. 3.15"	N Style 5
	F2 beige Arizona			H HUB (+)	O Style 6
	F3 grigio bromo			I Go	X XXL
	F4 black			J Normal	Y Point
	F6 blue fes			K Style 2	Z Top access
	F7 verde comodoro			L Style 3	
	F8 beige luxor				
	F9 rosso jaipur				
0.94" veneer A	0.94" veneer B			4) Positions grommet	
with matching edging	with matching edging			8 position 8, upcharge: + 73	
ES ash	ME fossile oak			9 position 9, upcharge: + 147	
NN walnut	GE fumed oak			(+) only on position 8	
NM walnut mismatched	TE teak			Positions, see p.139	
KE cherry	ZE zebrano			Price grommet, see price list Electrification	
EK European oak	PL Santos Rosewood				
EE black lacquered oak	WE wenge				

Code example: SB2715ELNNAWZ8 = 9.773

SB55

3. Oval meeting tables

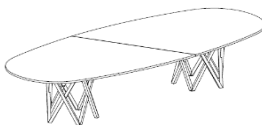
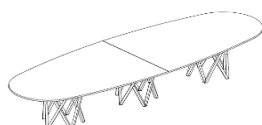
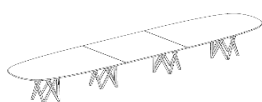

h 29.13"

			Melamine 0.98"	Fenix hpl 0.98"	Veneer A 0.94"	Veneer B 0.94"	List prices
		Code					
3.1. On 2 x 5V leg - top in 2 pieces with recessed supporting top in black mdf 0.98" thick							
	w 137.80" x d 59.06" x h 29.13"	SB3515OV *	7.635	9.775	12.025	15.755	
3.2. On 3 x 5V leg - top in 2 pieces							
	w 161.42" x d 59.06" x h 29.13"	SB4115OV *	9.200	11.780	14.490	18.985	
	w 177.17" x d 59.06" x h 29.13"	SB4515OV *	9.740	12.470	15.340	20.100	
	w 192.91" x d 59.06" x h 29.13"	SB4915OV *	10.270	13.150	16.175	21.190	
	w 208.66" x d 59.06" x h 29.13"	SB5315OV *	10.800	13.825	17.005	22.280	
3.3. On 4 x 5V leg - top in 3 pieces Central top = rectangular							
	w 259.84" x d 59.06" x h 29.13" central module w 66.93"	SB6615OV *	13.770	17.630	21.685	28.410	
	w 267.72" x d 59.06" x h 29.13" central module w 135.43"	SB6815OV *	14.040	17.975	22.110	28.965	
	w 275.59" x d 59.06" x h 29.13" central module w 66.93"	SB7015OV *	14.310	18.320	22.535	29.525	
	w 283.46" x d 59.06" x h 29.13" central module w 135.43"	SB7215OV *	14.575	18.660	22.955	30.075	

* FINISHES & CODES

1) Top		2) Base in solid wood		3) Grommet	
0.98" melamine	0.98" hpl Fenix	AB ash, black lacquered		00 without grommets (skip 4)	
01 lily white, with matching pvc edging	with black edging	ON natural oak		E diam. 2.36"	M Style 4
18 lily white with black pvc edging	F1 white	AW ash, walnut color stained		G diam. 3.15"	N Style 5
	F2 beige Arizona			H HUB (+)	O Style 6
	F3 grigio bromo			I Go	X XXL
	F4 black			J Normal	Y Point
	F6 blue fes			K Style 2	Z Top access
	F7 verde comodoro			L Style 3	
	F8 beige luxor				
	F9 rosso jaipur				
0.94" veneer A	0.94" veneer B			4) Positions grommet	
with matching edging	with matching edging			8 Position 8, cutout upcharge:	
ES ash	ME fossile oak			- for table with 2 legs	+ 73
NN walnut	GE fumed oak			- for table with 3 legs	+ 147
NM walnut mismatched	TE teak			- for table with 4 legs	+ 220
KE cherry	ZE zebrano			9 Position 9, cutout upcharge:	
EK European oak	PL Santos Rosewood			- for table with 2 legs	+ 147
EE black lacquered oak	WE wenge			- for table with 3 legs	+ 220
				- for table with 4 legs	+ 293

(+) only on position 8
Positions, see p.139
Price grommet, see price list Electrification

Code example: SB6615OV18ABJ8 = 13.990

SB55

4. Round meeting tables

h 29.13"			Melamine 0.98"	Fenix hpl 0.98"	Veneer A 0.94"	List prices Veneer B 0.94"
		Code				
4.1. Diam. 55.12" Top in 1 part On 1 x 5V leg	Diam. 55.12" leg space: 13.78"	SB14RO *	4.520	5.790	7.130	9.345

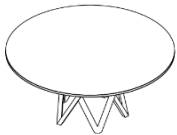

4.2. Diam. 62.99", 70.87" and 78.74"
Top in 3 parts with recessed supporting top in MDF 0.71" mm thick
Inside edges always matching the table top finish
On 3 x 2V leg

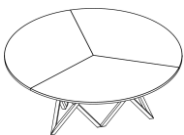

Diam. 62.99" leg space: 6.69" - 19.29"	SBMT16RO*	5.600	7.175	8.830	11.575
Diam. 70.87" leg space 10.63" - 23.23"	SBMT18RO *	6.040	7.735	9.515	12.465
Diam. 78.74" leg space 14.57" - 27.17"	SBMT20RO *	6.365	8.145	10.030	13.140



* FINISHES & CODES

1) Top		2) Base in solid wood		3) Grommet	
0.98" melamine	0.98" hpl Fenix	AB ash, black lacquered		00 without grommet	
01 lily white, with matching pvc edging	with black edging	ON natural oak		E8 diam. 2.36"	
18 lily white with black pvc edging	F1 white	AW ash, walnut color stained		G8 diam. 3.15"	
	F2 beige Arizona			Position always central	
	F3 grigio bromo			Upcharge per grommet cutout:	
	F4 black			+ 73	
	F6 blue fes			Price grommet, see price list Electrification	
	F7 verde comodoro				
	F8 beige luxor				
	F9 rosso jaipur				
0.94" veneer A	0.94" veneer B				
with matching edging	with matching edging				
ES ash	ME fossile oak				
NN walnut	GE fumed oak				
NM walnut mismatched	TE teak				
KE cherry	ZE zebrano				
EK European oak	PL Santos Rosewood				
EE black lacquered oak	WE wenge				

Code example: SB14ROF4AB00 = 5.790

SB55

5. Accessories

	Finish	Code	List prices
5.1. Cable net			
Cable net w.35.43"	grey black	ELCCN09UN08 ELCCN09UN04	220 220
5.2. Cable clamps			
 Single cable clamp 4.13", grey		ELCKK02	NET PRICES 22
 Double cable clamp 8.27", black		ELCKK04	22
5.3. Grommets			
See price list Electrification			

SB55

6. Colors and materials

MELAMINE

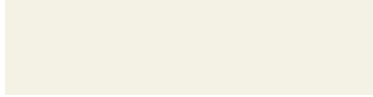

Lily white

FENIX HPL

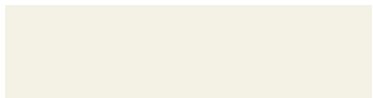

White 0029

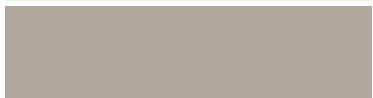

Beige Arizona 0748



Grigio bromo 0724



Black 0720



Blu fes 0754



Verde comodoro 0750



Beige luxor 0719



Rosso jaipur 0751

SOLID WOOD

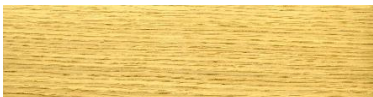

Natural oak



Black lacquered ash



Ash, walnut color stained

VENEER CATEGORY A



Ash



Walnut



Walnut mismatched



Cherry



European oak

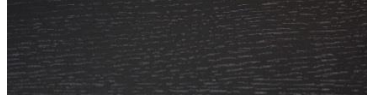

Black lacquered European oak

VENEER CATEGORY B



Fossile oak



Fumed oak

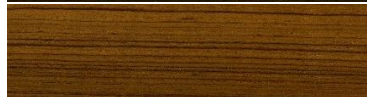

Teak



Zebrano



Santos rose wood



Wenge

Digital or paper printing is not binding

Senses

by Nathalie Van Reeth & BuloDesigners



Senses

by Nathalie Van Reeth & BuloDesigners

It is all about the senses.

Van Reeth's inspiration is about bringing softness and tactility back to the office or home through organic shapes and rich layers of materials and textures. People spend most of their life at work and she wanted to design a desk system that brings comfort to the mind and body and stimulates the senses. With a departure from rectilinear forms, the organic shapes paired with combinations of authentic materials such as micro-fibre, upcycled berries, woods and metals. Senses brings a softer and richer experience back to work.

ORGANIC SHAPES: EGG, BEAN & ROCK

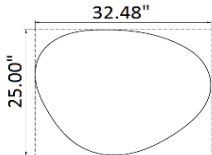

Egg, max w 32.48" x d 25.00"

For side tables

Fixed heights: 13.78", 21.65" and 29.53"

Base: organic shaped foot on oval central column in lacquered metal (black, grey-green or beige)

Top finishes: glass, veneer, Fenix hpl, melamine, Paperfactor

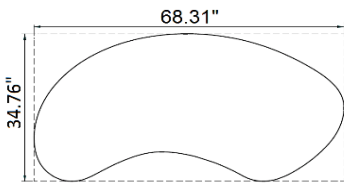

Bean, max. w 68.31" x d 27.56"/34.76"

For desk, benches and coffee tables

Heights: side table h 13.78" and desk/bench with fixed height 29.53" or electronically height adjustable 25.59" - 51.18"

Desk base: 2 black lacquered T-shaped legs or 2 oval legs (the large leg with 2 round holes for vertical cable management)

Bench base: black lacquered metal

Coffee table base: 2 oval legs

Oval legs finished in beech veneer, in walnut veneer or in lacquered black mdf.

Top finishes: Fenix hpl, melamine, veneer, Paperfactor

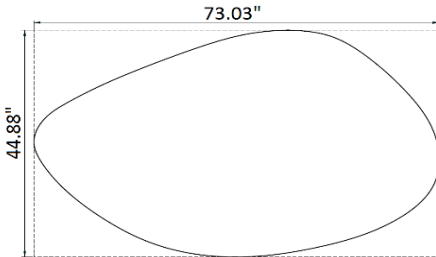

Rock, max. w 73.03" x d 44.88"

For desk/meeting table and coffee tables

Fixed heights: 13.98" and 29.53"

Top finishes: Fenix hpl, melamine, veneer, Paperfactor

Base: 2 oval legs (the large leg with 2 round holes for vertical cable management) finished in beech veneer, in walnut veneer or in lacquered black mdf.

EDGE FINISHES

Senses table tops finished in melamine, Fenix HPL and veneer have black edges

Melamine and Fenix HPL tops have black ABS edges

Black mdf tops with a veneer finish have transparently lacquered edges

Glass tops have a black mdf supporting top, with transparently lacquered edges

Paperfactor tops have the edges in the same material.

FENIX HPL

FENIX NTM® is a super opaque nanotech material. It combines elegant aesthetic solutions with state-of-the-art technological performance. The external surface of FENIX NTM® involves the use of nanotechnology that allows thermal healing of superficial micro-scratches. FENIX NTM® has low light reflectivity, is anti-fingerprint and features a very pleasant soft touch. It is highly resistant to scratches, abrasion, rubbing and dry heat. It significantly reduces the bacterial load making its surface hygienic and easy to clean. It is also liquid repellent and mould-proof.

PAPERFACTOR

Paperfactor is cellulose micro-fibers. The formula of components is based on an ancient Italian technique, originally used in the restoration of catholic statues. Paperfactor was developed in collaboration with the university of Salento (it), and is water resistant as well as fire retardant. Senses is the first furniture range ever to use this material.

Senses

by Nathalie Van Reeth & BuloDesigners

BENCHES

As a standard, all tops in a bench setup have the same finish, are all either with a fixed height (29.53") or all electronically height adjustable (25.59" - 51.18") and all have either no grommet or the same grommet on the same position.
For a mixture of both fixed height and electrical height adjustment within one bench, please contact us.
Cables can be guided through the horizontal beams of the bench base. Vertical cable management is not integrated.
Within a bench, 2 bean tops in a straight row are connected with a cable tray with cover.

ELECTRONICAL HEIGHT ADJUSTABILITY OF BEAN SINGLE DESKS ON T-LEGS AND BENCHES

Range: 25.59" - 51.18"

Display with up/down arrow

Cable with EU plug included. A separate mains lead is required if you require a different plug.



Control panel with display for height adjustable desks

WIRELESS CHARGER

Fixed to the underside of the desk top on the left hand side, the charger is not visible on the work surface and therefore does not affect the look of the desk.

The wireless charger can be applied on all types of work surfaces.

Only a Qi certified phone can be charged wireless (for example models as from iPhone 8, Samsung S6, Huawei Mate 20Pro, ...)

For phones that are not Qi certified, a separate Qi cover can be acquired.

It doesn't matter from which country the phone is. The system will recognize when it needs to transmit power to your device.

A small "tone" will indicate that your mobile device is in the right position. A small "buzz" indicates that the ZENS PuK is charging.

Output: 5 Watt. There are EU, UK and US power adapters available.

Usage: charges smartphones and smartwatches

GROMMET POSITIONS

To ensure the correct cutout is made in the top, the type of grommet and its position must be indicated with the Senses table.

Each Bean bench workstation will have the same grommet cutout in the same position. No grommet cutouts possible

in the meeting spaces of the closed configurations. The grommet itself has to be ordered separately and is not included in the price of the table.

SCREEN POSITIONS

All bean tops have inserts to place a Senses screen on 3 positions: left, central and right

circles: round grommet

- 1 left
- 3 central
- 5 right

dotted circle: wireless charger

shaded rectangle: cable net

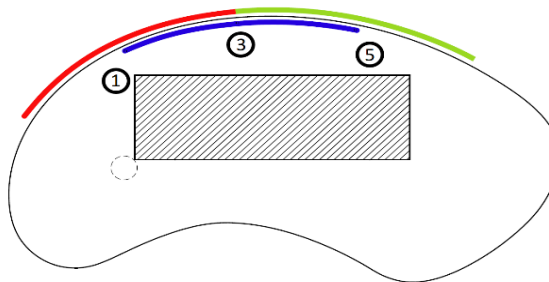

red: screen left
blue: screen central
green: screen right

Senses

1. Single desk, bean shape

ca. w 68.31" x d 27.56"/34.76"

List prices

Base	Code	Melamine 0.98"	HPL Fenix 1.02"	Veneer A 1.02"	Veneer B 1.02"
------	------	-------------------	--------------------	-------------------	-------------------

1.1. Electronically height adjustable, on T-legs, h 25.59" - 51.18"

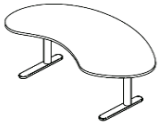

Black lacquered metal

SESIELSN4BN *

4.100

4.900

5.375

5.905

1.2. Fixed height on T-legs, h 29.53"

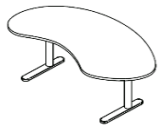

Black lacquered metal

SESIFISN4BN *

2.155

2.955

3.415

3.955

1.3. Fixed height on oval legs, h 29.53"

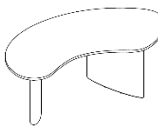

Lacquered black mdf

SESIOVS04BN *

3.900

4.690

5.160

5.700

Natural beech veneer

SESIOVSBNBN *

4.365

5.165

5.630

6.175

Natural walnut veneer

SESIOVSWABN *

4.450

5.250

5.715

6.260

* FINISHES & CODES

<u>1) Top</u>		<u>2) Grommet type</u>	<u>3) Position grommet</u>
25 mm melamine, black ABS edges	26 mm veneer A, black abs lacquered edges	00 without grommet (skip 3)	1 position 1
2501 lily white	26ES ash	E round, diam. 2.36"	3 position 3
25RB royal blue	26NN walnut	Upcharge per grommet cutout:	5 position 5
25AN anthracite	26NM walnut mismatched	+ 45	Positions, see p.149
25CO coco	26KE cherry	Price grommet, see p.161	
25TR truffle grey	26EK oak		
	26EE black lacquered oak		
26 mm hpl Fenix, black ABS edges	26 mm veneer B, black abs lacquered edges		
26F1 lily white	26ME fossile oak		
26F2 beige Arizona	26GE fumed oak		
26F3 grigio bromo	26TE teak		
26F4 black	26ZE zebrano		
26F6 blu fes	26PL Santos Rose Wood		
26F7 verde comodoro	26WE wenge		
26F8 beige luxor			
26F9 rosso jaipur			

Option: wireless cellphone charger, see p.178

Code example SESIELSN4BN26F6E5 = 4.945

Senses

2. Benches

For 2 persons

List prices

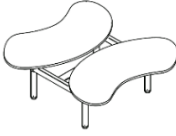
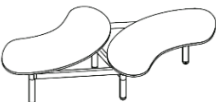
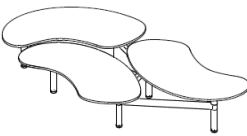
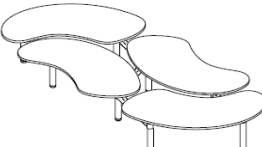
	Code	Melamine 0.98"	HPL Fenix 1.02"	Veneer A 1.02"	Veneer B 1.02"
2.1. Bench for 2 persons					
2.1.1. Double configuration, total dim.: w 69.69" x d 74.02"					
	Tops electronically height adjustable				
	SEDOELSN4BN *	8.830	10.425	11.365	12.430
	Tops with fixed height 29.53"				
	SEDOFISN4BN *	4.935	6.530	7.470	8.535
2.1.2. Open configuration, total dim.: w 98.43" x d 66.54"					
	Tops electronically height adjustable				
	SEO2ELSN4BN *	9.065	10.655	11.590	12.660
	Tops with fixed height 29.53"				
	SEO2FISN4BN *	5.170	6.760	7.695	8.765
2.1.3. Closed configuration, with meeting space, total dim.: w 120.87" x d 66.54"					
	Tops electronically height adjustable				
	SEC3ELSN4BN *	13.310	15.700	17.110	18.705
	Tops with fixed height 29.53"				
	SEC3FISN4BN *	7.470	9.855	11.265	12.865
2.1.4. Closed configuration, with 2 meeting spaces, total dim.: w 143.31" x d 66.54"					
	Tops electronically height adjustable				
	SEC4ELSN4BN *	17.550	20.735	22.620	24.755
	Tops with fixed height 29.53"				
	SEC4FISN4BN *	9.760	12.945	14.825	16.965

* FINISHES & CODES

		<u>1) Top</u>	<u>2) Grommet type</u>	<u>3) Position grommet</u>
25 mm melamine, black ABS edges		26 mm veneer A, black abs lacquered edges	00 without grommet (skip 3)	1 position 1
2501 lily white		26ES ash	E round, diam. 2.36"	3 position 3
25RB royal blue		26NN walnut		5 position 5
25AN anthracite		26NM walnut mismatched		
25CO coco		26KE cherry	Upcharge per grommet cutout:	
25TR truffle grey		26EK oak	+ 45	
		26EE black lacquered oak	Price grommet, see p.161	Positions, see p.149
26 mm hpl Fenix, black ABS edges		26 mm veneer B, black abs lacquered edges	Each workstation has an identical grommet cutout.	
26F1 lily white		26ME fossile oak	No grommet cutouts in the meeting space tops.	
26F2 beige Arizona		26GE fumed oak		
26F3 grigio bromo		26TE teak		
26F4 black		26ZE zebrano		
26F6 blu fes		26PL Santos Rose Wood		
26F7 verde comodoro		26WE wenge		
26F8 beige luxor				
26F9 rosso jaipur				





Option: wireless cellphone charger, see p.178

Code example SEC3ELSN4BN25TRE3 = 13.445

Senses

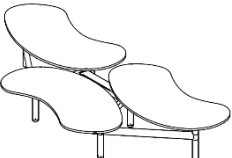
Benches

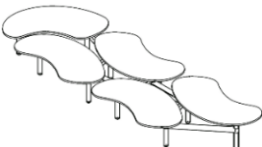
For 3 or 4 persons

	Code	Melamine 0.98"	HPL Fenix 1.02"	Veneer A 1.02"	Veneer B 1.02"	List prices
2.2. Bench for 3 persons - open configuration, total dim.: w 135.83" x d 66.54"						
	Tops electronically height adjustable					
	SEO3ELSN4BN *	13.505	15.895	17.305	18.900	
	Tops with fixed height 29.53"					
	SEO3FISN4BN *	7.665	10.050	11.460	13.060	
2.3 Bench for 4 persons						
2.3.1. Open configuration, total dim.: w 167.32" x d 66.54"						
	Tops electronically height adjustable					
	SEO4ELSN4BN *	17.965	21.145	23.025	25.160	
	Tops with fixed height 29.53"					
	SEO4FISN4BN *	10.175	13.350	15.235	17.370	
2.3.2. Closed configuration, with meeting space, total dim.: w 189.76" x d 66.54"						
	Tops electronically height adjustable					
	SEC5ELSN4BN *	22.210	26.190	28.535	31.200	
	Tops with fixed height 29.53"					
	SEC5FISN4BN *	12.470	16.450	18.795	21.460	
2.3.3. Closed configuration, with 2 meeting spaces, total dim.: w 212.20" x d 66.54"						
	Tops electronically height adjustable					
	SEC6ELSN4BN *	26.465	31.240	34.060	37.255	
	Tops with fixed height 29.53"					
	SEC6FISN4BN *	14.780	19.555	22.375	25.570	

* FINISHES & CODES

		<u>1) Top</u>	<u>2) Grommet type</u>	<u>3) Position grommet</u>
25 mm melamine, black ABS edges		26 mm veneer A, black abs lacquered edges	00 without grommet (skip 3)	1 position 1
2501 lily white		26ES ash	E round, diam. 2.36"	3 position 3
25RB royal blue		26NN walnut		5 position 5
25AN anthracite		26NM walnut mismatched	Upcharge per grommet cutout:	
25CO coco		26KE cherry	+ 45	
25TR truffle grey		26EK oak	Price grommet, see p.161	
		26EE black lacquered oak		Positions, see p.149
26 mm hpl Fenix, black ABS edges		26 mm veneer B, black abs lacquered edges	Each workstation has an identical grommet cutout.	
26F1 lily white		26ME fossile oak	No grommet cutouts in the meeting space tops.	
26F2 beige Arizona		26GE fumed oak		
26F3 grigio bromo		26TE teak		
26F4 black		26ZE zebrano		
26F6 blu fes		26PL Santos Rose Wood		
26F7 verde comodoro		26WE wenge		
26F8 beige luxor				
26F9 rosso jaipur				



Option: wireless cellphone charger, see p.178

Code example SEO4FISN4BN26F200 = 13.350

Senses

Benches

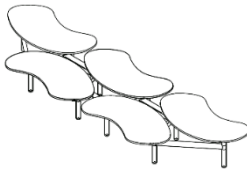
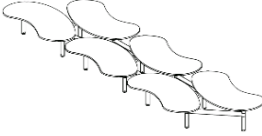
For 5 or 6 persons

	Code	Melamine 0.98"	HPL Fenix 1.02"	Veneer A 1.02"	Veneer B 1.02"	List prices
2.4. Bench for 5 persons - open configuration, total dim.: w 204.72" x d 66.54"						
	Tops electronically height adjustable	SEO5ELSN4BN *	22.415	26.400	28.750	31.415
	Tops with fixed height 29.53"	SEO5FISN4BN *	12.675	16.660	19.010	21.675
2.5. Bench for 6 persons						
2.5.1. Open configuration, total dim.: w 236.22" x d 66.54"						
	Tops electronically height adjustable	SEO6ELSN4BN *	26.865	31.640	34.460	37.655
	Tops with fixed height 29.53"	SEO6FISN4BN *	15.180	19.955	22.775	25.970
2.5.2. Closed configuration, with meeting space, total dim.: w 258.66" x d 66.54"						
	Tops electronically height adjustable	SEC7ELSN4BN *	31.120	36.685	39.980	43.710
	Tops with fixed height 29.53"	SEC7FISN4BN *	17.485	23.050	26.345	30.075
2.5.3. Closed configuration, with 2 meeting spaces, total dim.: w 281.10" x d 66.54"						
	Tops electronically height adjustable	SEC8ELSN4BN *	35.365	41.730	45.490	49.760
	Tops with fixed height 29.53"	SEC8FISN4BN *	19.785	26.150	29.905	34.175

* FINISHES & CODES

		<u>1) Top</u>	<u>2) Grommet type</u>	<u>3) Position grommet</u>
25 mm melamine, black ABS edges		26 mm veneer A, black abs lacquered edges	00 without grommet (skip 3)	1 position 1
2501	lily white	26ES ash	E round, diam. 2.36"	3 position 3
25RB	royal blue	26NN walnut	Upcharge per grommet cutout: + 45	5 position 5
25AN	anthracite	26NM walnut mismatched		Positions, see p.149
25CO	coco	26KE cherry		
25TR	truffle grey	26EK oak		
		26EE black lacquered oak		
26 mm hpl Fenix, black ABS edges		26 mm veneer B, black abs lacquered edges	Each workstation has an identical grommet cutout. No grommet cutouts in the meeting space tops.	
26F1	lily white	26ME fossile oak		
26F2	beige Arizona	26GE fumed oak		
26F3	grigio bromo	26TE teak		
26F4	black	26ZE zebrano		
26F6	blu fes	26PL Santos Rose Wood		
26F7	verde comodoro	26WE wenge		
26F8	beige luxor			
26F9	rosso jaipur			

Option: wireless cellphone charger, see p.178

Code example SEO6FISN4BN2501E1 = 15.450

Senses

Benches

For 7 persons

		Melamine	HPL Fenix	Veneer A	Veneer B
	Code	0.98"	1.02"	1.02"	1.02"
2.6. Cluster of 7 - open configuration, total dim.: w 273.62" x d 66.54"					
	Tops electronically height adjustable				
	SEO7ELSN4BN *	31.315	36.890	40.180	43.905
	Tops with fixed height 29.53"				
	SEO7FISN4BN *	17.680	23.255	26.545	30.270

* FINISHES & CODES

<u>1) Top</u>		<u>2) Grommet type</u>	<u>3) Position grommet</u>
25 mm melamine, black ABS edges	26 mm veneer A, black abs lacquered edges	00 without grommet (skip 3)	1 position 1
2501 lily white	26ES ash	E round, diam. 2.36"	3 position 3
25RB royal blue	26NN walnut		5 position 5
25AN anthracite	26NM walnut mismatched	Upcharge per grommet cutout:	
25CO coco	26KE cherry	+ 45	Positions, see p.149
25TR truffle grey	26EK oak	Price grommet, see p.161	
	26EE black lacquered oak		
26 mm hpl Fenix, black ABS edges	26 mm veneer B, black abs lacquered edges	Each workstation has an identical grommet cutout. No grommet cutouts in the meeting space tops.	
26F1 lily white	26ME fossile oak		
26F2 beige Arizona	26GE fumed oak		
26F3 grigio bromo	26TE teak		
26F4 black	26ZE zebrano		
26F6 blu fes	26PL Santos Rose Wood		
26F7 verde comodoro	26WE wenge		
26F8 beige luxor			
26F9 rosso jaipur			

Option: wireless cellphone charger, see p.178

Code example SEO7FISN4BN26NNE3 = 26.860

Senses

3. Executive/meeting table, rock shape, h.29.53"

List prices

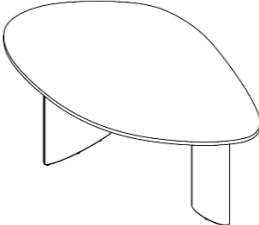
	Base finish	Code	Melamine 0.98"	HPL Fenix 1.02"	Veneer A 1.02"	Veneer B 1.02"	Paper F. 0.98"
w 73.03" x d 44.88"							
	Lacquered black mdf	SEMTOVS04RO *	5.090	6.500	7.115	7.825	13.310 (+)
	Natural beech veneer	SEMTOVSBNRO *	5.510	6.915	7.535	8.250	13.735 (+)
	Natural walnut veneer	SEMTOVSWARO *	5.660	7.060	7.680	8.395	13.880 (+)

* FINISHES & CODES

<u>1) Top</u>		<u>2) Grommet type</u>	
25 mm melamine, black ABS edges	26 mm veneer A, black abs lacquered edges	25mm Paperfactor (+)	00 without grommet (skip 3)
2501 lily white	26ES ash	25P1 white informale	E round, diam. 2.36"
25RB royal blue	26NN walnut	25P2 grigio informale	Upcharge per grommet cutout:
25AN anthracite	26NM walnut mismatched	25P4 black informale	+ 45
25CO coco	26KE cherry	25P5 olive terrazzo	Price grommet, see p.161
25TR truffle grey	26EK oak	25P6 blue informale	(+) no grommet possible in Paperfactor
	26EE black lacquered oak		
26 mm hpl Fenix, black ABS edges	26 mm veneer B, black abs lacquered edges		<u>3) Position grommet</u>
26F1 lily white	26ME fossile oak		7 position 7
26F2 beige Arizona	26GE fumed oak		8 position 8
26F3 grigio bromo	26TE teak		
26F4 black	26ZE zebrano		
26F6 blu fes	26PL Santos Rose Wood		
26F7 verde comodoro	26WE wenge		
26F8 beige luxor			
26F9 rosso jaipur			

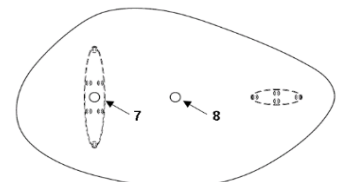



Code example SEMTOVSWARO25P200 = 13.880

Senses

4. Egg side tables and coffee tables, w 32.48" x d 25"

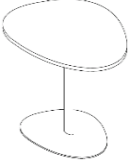
List prices

	Base finish	Code	Melamine 0.98"	HPL Fenix 1.02"	Veneer A 1.02"	Veneer B 1.02"	Paper F. 0.98"
4.1. h 29.53"							
	Black	SESTFIS04EG * 00	1.200	1.380	1.855	1.965	4.795
	Grey-green	SESTFISGGEG * 00	1.340	1.520	1.990	2.105	4.935
4.2. h 21.65"							
	Black	SESTFIM04EG * 00	1.190	1.370	1.845	1.960	4.780
	Grey-green	SESTFIMGGEG * 00	1.330	1.510	1.985	2.095	4.915
4.3. h 13.78"							
	Black	SESTFIL04EG * 00	1.185	1.355	1.830	1.950	4.755
	Grey-green	SESTFILGGEG * 00	1.325	1.495	1.965	2.090	4.890

* FINISHES & CODES

Top		
25 mm melamine, black ABS edges	26 mm veneer A, black abs lacquered edges	25mm Paperfactor
2501 lily white	26ES ash	25P1 white informale
25RB royal blue	26NN walnut	25P2 grigio informale
25AN anthracite	26NM walnut mismatched	25P4 black informale
25CO coco	26KE cherry	25P5 olive terrazzo
25TR truffle grey	26EK oak	25P6 blue informale
	26EE black lacquered oak	
26 mm hpl Fenix, black ABS edges	26 mm veneer B, black abs lacquered edges	
26F1 lily white	26ME fossile oak	
26F2 beige Arizona	26GE fumed oak	
26F3 grigio bromo	26TE teak	
26F4 black	26ZE zebrano	
26F6 blu fes	26PL Santos Rose Wood	
26F7 verde comodoro	26WE wenge	
26F8 beige luxor		
26F9 rosso jaipur		

Code example SESTFIL04EG26F100 = 1.355

Senses

5. Bean and Rock coffee tables, h 13.78"

List prices

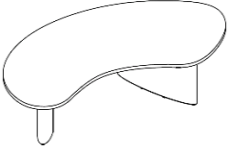
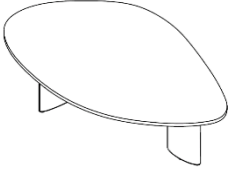
	Base finish	Code	Melamine 0.98"	HPL Fenix 1.02"	Veneer A 1.02"	Veneer B 1.02"	Paper F. 0.98"
5.1. Bean, w 66.54" x d 34.76" x h 13.78"							
	Lacquered black mdf	SESTOVL04BN * 00	3.125	3.915	4.385	4.925	7.165
	Natural beech veneer	SESTOVLBNBN * 00	3.240	4.035	4.500	5.040	7.270
	Natural walnut veneer	SESTOVLWABN * 00	3.310	4.110	4.575	5.115	7.355
5.2. Rock, w 73.03" x d 44.88" x h 13.78"							
	Lacquered black mdf	SESTOVL04RO * 00	4.315	5.725	6.345	7.050	9.260
	Natural beech veneer	SESTOVLBNRO * 00	4.445	5.845	6.465	7.175	9.385
	Natural walnut veneer	SESTOVLWARO * 00	4.520	5.920	6.540	7.250	9.455

* FINISHES & CODES

Top		
25 mm melamine, black ABS edges	26 mm veneer A, black abs lacquered edges	25mm Paperfactor
2501 lily white	26ES ash	25P1 white informale
25RB royal blue	26NN walnut	25P2 grigio informale
25AN anthracite	26NM walnut mismatched	25P4 black informale
25CO coco	26KE cherry	25P5 olive terrazzo
25TR truffle grey	26EK oak	25P6 blue informale
	26EE black lacquered oak	
26 mm hpl Fenix, black ABS edges	26 mm veneer B, black abs lacquered edges	
26F1 lily white	26ME fossile oak	
26F2 beige Arizona	26GE fumed oak	
26F3 grigio bromo	26TE teak	
26F4 black	26ZE zebrano	
26F6 blu fes	26PL Santos Rose Wood	
26F7 verde comodoro	26WE wenge	
26F8 beige luxor		
26F9 rosso jaipur		

Code example SESTOVLBNBN25P400 = 7.270

Senses

6. Meeting tables, h.29.53"

List prices

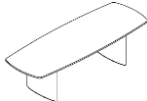
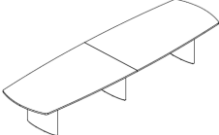
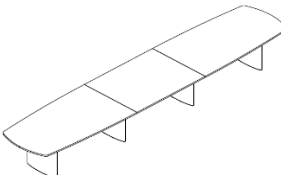
	Base finish	Code	Melamine HPL Fenix Veneer A Veneer B			
			0.98"	1.02"	1.02"	1.02"
6.1. w 98.43" x d 35.43" x h.29.53"						
	Lacquered black mdf	SEMTOVS0425 *	5.210	6.435	7.190	7.850
	Natural beech veneer	SEMTOVSBN25 *	5.690	6.915	7.670	8.330
	Natural walnut veneer	SEMTOVSWA25 *	5.855	7.085	7.845	8.505
6.2. w 157.48" x d 45.67" x h 29.53"						
	Lacquered black mdf	SEMTOVS0440 *	7.990	11.015	12.140	13.855
	Natural beech veneer	SEMTOVSBN40 *	8.725	11.745	12.870	14.590
	Natural walnut veneer	SEMTOVSWA40 *	8.965	12.000	13.125	14.845
6.3. w 216.54" x d 45.67 x h 29.53" (w 78.74" + 59.06" + 78.74")						
	Lacquered black mdf	SEMTOVS0455 *	10.860	15.130	16.050	19.130
	Natural beech veneer	SEMTOVSBN55 *	11.835	16.100	17.020	20.110
	Natural walnut veneer	SEMTOVSWA55 *	12.170	16.435	17.360	20.445

* FINISHES & CODES

1) Top		2) Grommet type	3) Position grommet
25 mm melamine, black ABS edges	26 mm veneer A, black abs lacquered edges	00 without grommet (skip 3)	8 position 8
2501 lily white	26ES ash	E round, diam. 2.36"	
25RB royal blue	26NN walnut		
25AN anthracite	26NM walnut mismatched	Upcharge per grommet cutout:	
25CO coco	26KE cherry	+ 45	
25TR truffle grey	26EK oak	Price grommet, see p.161	
	26EE black lacquered oak		
26 mm hpl Fenix, black ABS edges	26 mm veneer B, black abs lacquered edges	If with grommet, each module will have the same grommet cutout in the same position	
26F1 lily white	26ME fossile oak		
26F2 beige Arizona	26GE fumed oak		
26F3 grigio bromo	26TE teak		
26F4 black	26ZE zebrano		
26F6 blu fes	26PL Santos Rose Wood		
26F7 verde comodoro	26WE wenge		
26F8 beige luxor			
26F9 rosso jaipur			

Positions grommet:

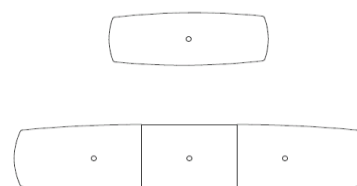



Code example SEMTOVSWA5526NN00 = 17.360

Senses

Meeting tables, h.29.53"

List prices

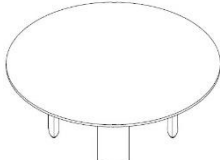
	Base finish	Code	Melamine 0.98"	HPL Fenix 1.02"	Veneer A 1.02"	Veneer B 1.02"
6.4. Diam. 55.12"						
	Lacquered black mdf	SEMTOVS04R14 *	4.915	5.600	6.100	6.435
	Natural beech veneer	SEMTOVSBNR14 *	5.340	6.025	6.520	6.855
	Natural walnut veneer	SEMTOVSWAR14 *	5.495	6.180	6.675	7.010
6.5. Diam. 62.99"						
	Lacquered black mdf	SEMTOVS04R16 *	5.420	6.300 (+)	6.480	7.625
	Natural beech veneer	SEMTOVSBNR16 *	5.845	6.725 (+)	6.905	8.045
	Natural walnut veneer	SEMTOVSWAR16 *	6.000	6.880 (+)	7.060	8.200
6.6. Diam. 70.87"						
	Lacquered black mdf	SEMTOVS04R18 *	5.975	7.110 (+)	8.200	8.740
	Natural beech veneer	SEMTOVSBNR18 *	6.400	7.535 (+)	8.625	9.165
	Natural walnut veneer	SEMTOVSWAR18 *	6.555	7.690 (+)	8.780	9.320
6.7. Diam. 78.74"						
	Lacquered black mdf	SEMTOVS04R20 *	6.605 (+)	8.290 (+)	10.050	10.435
	Natural beech veneer	SEMTOVSBNR20 *	7.030 (+)	8.715 (+)	10.475	10.860
	Natural walnut veneer	SEMTOVSWAR20 *	7.185 (+)	8.870 (+)	10.630	11.015

* FINISHES & CODES

<u>1) Top</u>		<u>2) Grommet type</u>	<u>3) Position grommet</u>
25 mm melamine, black ABS edges	26 mm veneer A, black abs lacquered edges	00 without grommet (skip 3)	8 position 8
2501 lily white	26ES ash	E round, diam. 2.36"	
25RB royal blue	26NN walnut		
25AN anthracite	26NM walnut mismatched	Upcharge per grommet cutout:	
25CO coco	26KE cherry	+ 45	
25TR truffle grey	26EK oak	Price grommet, see p.161	
	26EE black lacquered oak		
26 mm hpl Fenix, black ABS edges	26 mm veneer B, black abs lacquered edges		
26F1 lily white	26ME fossile oak		
26F2 beige Arizona	26GE fumed oak		
26F3 grigio bromo	26TE teak		
26F4 black	26ZE zebrano		
26F6 blu fes	26PL Santos Rose Wood		
26F7 verde comodoro	26WE wenge		
26F8 beige luxor			
26F9 rosso jaipur			

(+) Top in 2 pieces with organic division:

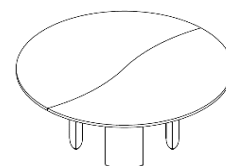

In melamine tops diam. 2000 mm
In hpl tops as from diam. 1600 mm
Veneer tops always in 1 piece

Code example SEMTOVSBNR1626F100 = 6.725

Senses

7. Accessories

List prices

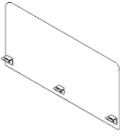
	Code	Fabric				
		Cat. 1	Cat. 2	Cat. 3	Cat. 4	Cat. 5
7.1. Screen for Bean desk, upholstered. 3.94" stays underneath the top. Fixed with 3 black L-shaped profiles to the underside of the desk						
 w 31.50" x h 15.75", curved	SEWND *	965	1.040	1.095	1.185	1.290
	Code					List prices

7.2. Wireless cellphone charger 15W

Apple & Samsung fast charging device, diam. 3.15"

Fixed to the underside of the desk top on a fixed position on the left hand side, (template positions see p.149). The charger is not visible on the work surface and therefore does not affect the look of the desk.

Wireless charger (including cable clamp and fittings) with EU power adaptor SENCHAR 320

Code NET PRICES

7.3. Vertical cable management set for height adjustable Bean desk/bench (cable net/cable clamps not included)

For single desk	CMICMSS02US	255
For bench with 2 tops	CMICMSS04US	370
For bench with 3 tops	CMICMSS06US	490
For bench with 4 tops	CMICMSS08US	605
For bench with 5 tops	CMICMSS10US	850
For bench with 6 tops	CMICMSS12US	990

Composition of the sets - pieces per height adjustable desk/bench:

Single desk	Bench 2 tops	Bench 3 tops	Bench 4 tops	Bench 5 tops	Bench 6 tops	
1	2	3	4	5	6	Underdesk socket outlet with 4 x power
1	2	3	4	5	4	Connecting lead 78.74" long from underdesk socket outlet to connector
-	-	-	-	-	2	Connecting lead 118.11" long from underdesk socket outlet to connector
1	1	1	1	2	2	Connector 1 in 5 out ,to distribute the connecting leads to the power sockets
1	1	1	1	2	2	Mains lead, l.4000 mm from floor box to connector
1	2	3	4	5	6	Cable sleeve, black, l.1400 mm, from horizontal cable duct to height adjustable top
1	1	1	1	2	2	Cable sleeve, black, l.4000 mm from horizontal cable duct to floor box
4	8	12	16	20	24	Small velcro fastener to strap cables together
2	4	6	8	10	12	Adhesive cable clips, to attach the display cable to the underside of the desk top

FINISHES & CODES



* Screen upholstery

Fabric cat. 1	Fabric cat. 3	Fabric cat. 4	Fabric cat. 5
CLW... Carlow	BL... Blazer	AR... Arco	HA... Hallingdal 65
QU... Quest	LALO... Lobo	CA... Canvas 2	CT... Steelcut 3
	ME... Meld	CL... Cleo	TR... Steelcut Trio 3
Fabric cat. 2	MR... Merit	CR... Credo	VI... Vidar 4
MLF... Main Line Flax	RE... Remix 3	SH... Shake	
	RW... Re-wool	TP... Topia	

... = add fabric color code

Senses

Accessories

		Code	List prices
<hr/>			
7.4. Cable net for horizontal cable management, w 35.43" x d 16.14", black		ELCCN09SE04	215
<hr/>			
		Code	NET PRICES
<hr/>			
7.5. Cable clamps for horizontal cable management			
	Single cable clamp 4.13", grey	ELCKK02	22
	Double cable clamp 8.27", black	ELCKK04	22
7.6. Round grommet, diam. 2.36" With brush profile	Finish:		
	pvc, black	CM60PLZW	10
	pvc, white	CM60PLWI	10
	aluminium	CM60ALU	18
	aluminium, chrome look	CM60CH	18
	aluminium, black	CM60ZW	21

Senses

8. Colors and materials





MELAMINE, black abs edges

	Lily white W980 ST7
	Royal blue U599 ST9
	Anthracite U960 ST9
	Coco U399 ST9
	Truffle grey U727 ST9



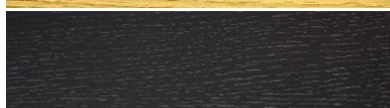

FENIX HPL, black abs edges

	Lily white 0029
	Beige Arizona 0748
	Grigio bromo 0724
	Black 0720
	Blu fes 0754
	Verde comodoro 0750
	Beige luxor 0719
	Rosso jaipur 0751

VENEER CATEGORY A, black abs lacquered edges

	Ash
	Walnut
	Walnut mismatched
	Cherry
	European oak
	Black lacquered European oak

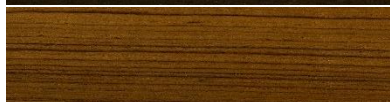
VENEER CATEGORY B, black abs lacquered edges

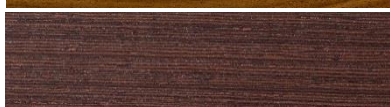
	Fossile oak
	Fumed oak
	Teak
	Zebrano
	Santos rose wood
	Wenge

Senses

Colors and materials

OVAL BASES FOR BEAN, ROCK AND MEETING TABLES



Walnut veneer



Beech veneer



Lacquered black mdf

BENCH BASE AND T-LEGS FOR BEAN



Black, ral 9005

PAPERFACTOR

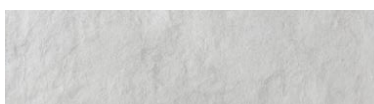

White informale



Grigio informale

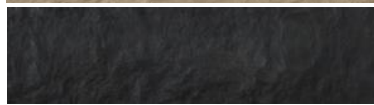

Black informale

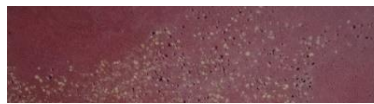

Olive terrazzo



Blue informale

EGG BASE



Black, ral 9005



Grey-green
ral 7003

VVD Desk

by Vincent Van Duysen



VVD Desk

by Vincent Van Duysen

Desk is Vincent Van Duysen's interpretation of the "cubicle" desk system. Minimal yet beautifully detailed, the VVD Desk has timeless aesthetics. It is Van Duysen's architecture scaled down to a compact piece of furniture.

Executive desk

L-shaped panel either at the left hand side or at the right hand side
w 98.03" x d 39.88" x h 37.40"
Work top height: 29.53"

Finishes:

- HPL :
- side panels with Corian edges, w 1.77" x h 0.47"
 - the parts of the panels facing the users are upholstered with Divina fabric by Kvadrat
 - top with a grommet type Normal (built-in socket outlet not included, see price list Electrification)
Grommet frame in chrome, cover in the same HPL as the top
 - cable net included

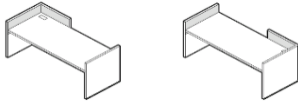

Wenge veneer:

- side panels with edges in solid wenge wood, w 1.77" x h 0.47"
- the parts of the panels facing the users are upholstered with black saddle leather
The work top partly has an inlay in black saddle leather on the side of the L-shaped panel
- top with a grommet type Normal (built-in socket outlet not included, see price list Electrification) in the saddle leather inlay
Grommet frame in coffee bean color lacquered, cover in black saddle leather
- cable net included

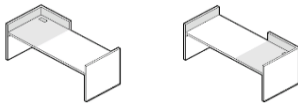

VVD Desk

Executive

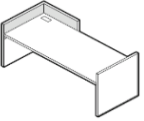
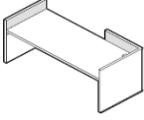
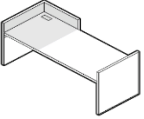
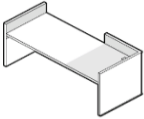
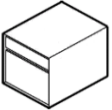
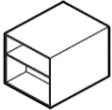
		Finish	Interior upholstery	Edges	Code	List prices
Executive desk in HPL w 98.03" x d 39.88" x h 29.53"/37.40"						
	<u>L-shaped panel</u>	<u>HPL</u>	<u>Fabric Divina</u>	<u>Corian</u>		
	left	lily white	coffee bean	Cameo white	VVDBTS01DIL	17 605
	right	lily white	coffee bean	Cameo white	VVDBTS01DIR	17 605
Executive desk in wenge veneer w 98.03" x d 39.88" x h 29.53"/37.40"						
	<u>L-shaped panel</u>	<u>Veneer</u>	<u>Saddle leather</u>	<u>Solid wood</u>		
	left	wenge	black	wenge	VVDBTSTLWEL	27 965
	right	wenge	black	wenge	VVDBTSTLWER	27 965
Executive pedestal w 31.50" x d 37.44" x h 29.53" Pedestal with desk height and depth Front with 1 normal and 1 filing drawer Back open with fixed shelf						
	front	HPL lily white			VVD LKT101	4 670
	back	wenge veneer			VVDLKT1WE	8 880

VVD Desk

5. Colors and materials

HPL



lily white

VENEER / SOLID WOOD



wenge

DIVINA 3 BY KVADRAT



coffee bean, 384

SADDLE LEATHER

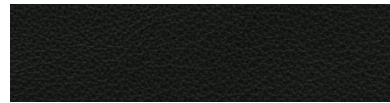

black

CORIAN

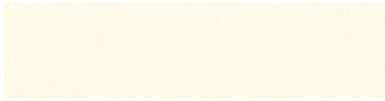

cameo white

Screens

by BuloDesign

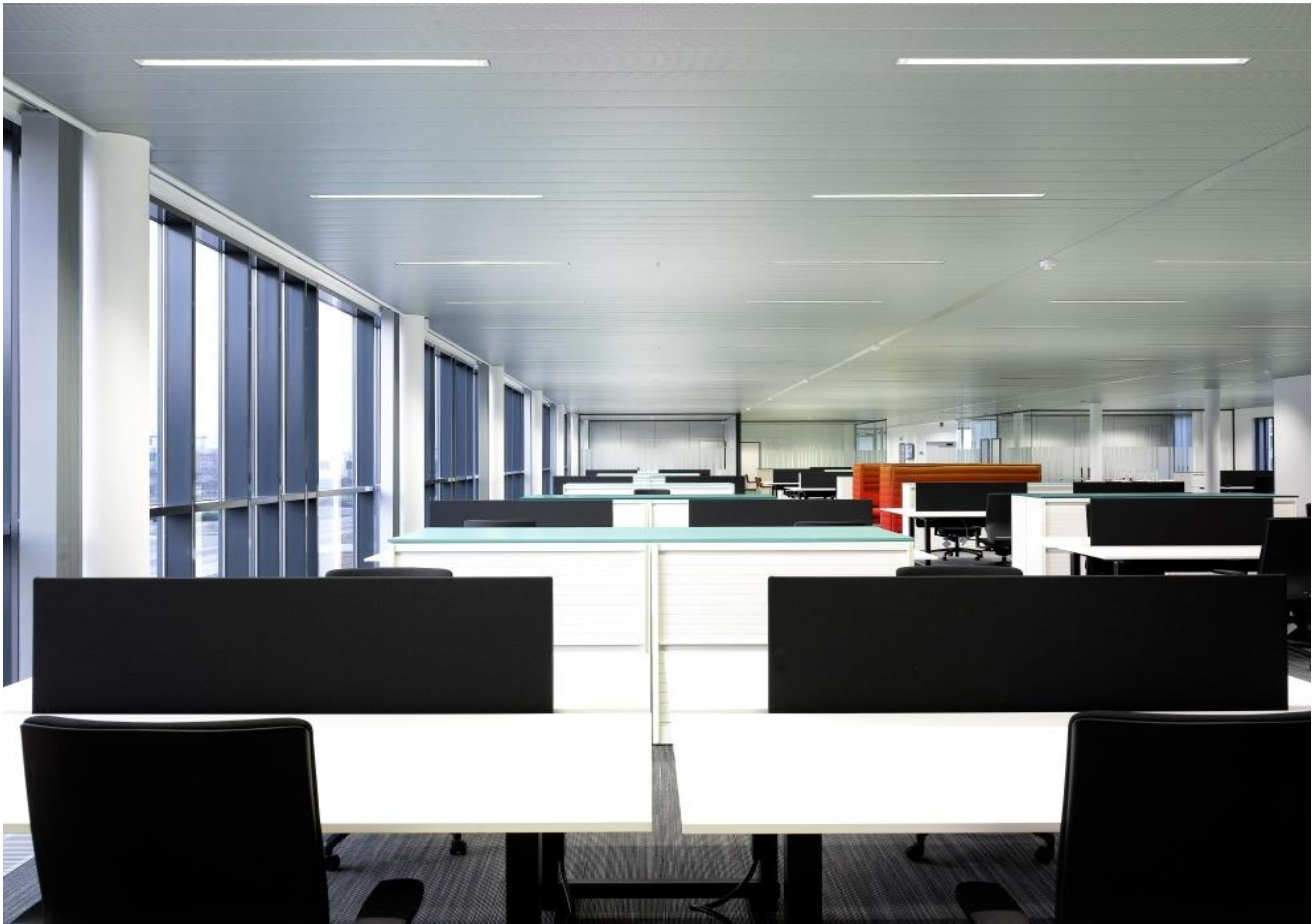

Screens

by BuloDesign

Possible finishes non-acoustic screens: lacquered mdf or veneered mdf
 Acoustic screens are always upholstered

Screen fixed with clamps to the table top

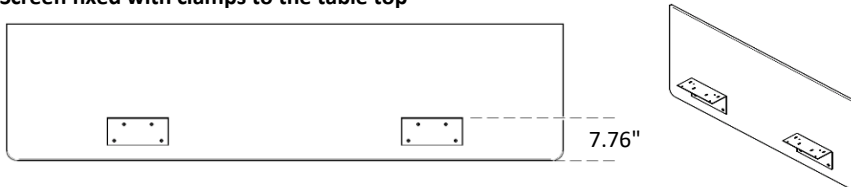

Possible finishes clamps: aluminium color, lily white lacquer or black lacquer
 h 7.76" of the screen sits under the underside of the desk top

Built-in screen with pins through the top

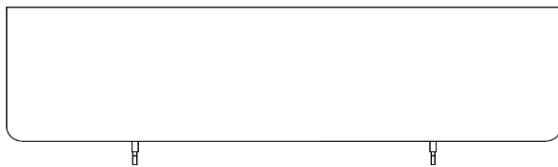

Possible finishes pins: aluminium color, lily white lacquer or black lacquer
 The pins are 1.18" high (not included in the screen heights)

Possible screen positions on the table top (to be indicated with the table to ensure correct fittings in the top)

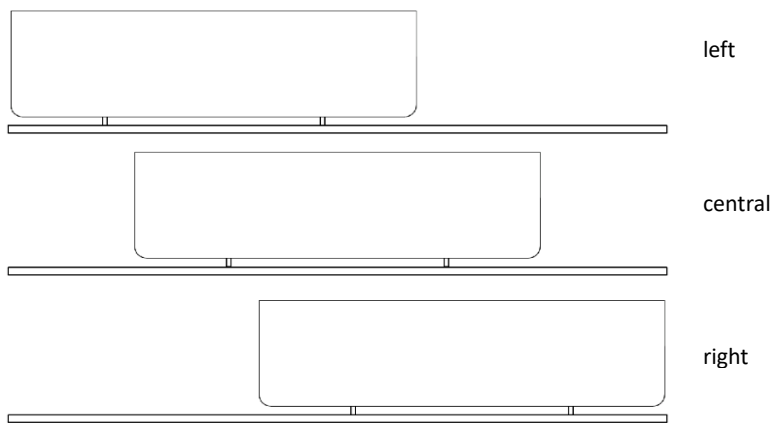

Freestanding screen on 2 feet

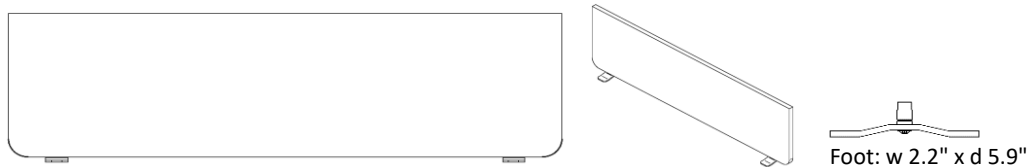

The feet are 0.59 high (not included in the screen heights)

Screens

by BuloDesign

TECHNICAL DESCRIPTION ACOUSTIC PANELS

Material: 100 % polyester
Weight: 4000 g/10.76 ft²
Thickness: 0.98"

Made from compressed recyclable polyester fibers, the acoustic felt panels are very efficient as sound insulation. Thanks to the flexible composition of the panels, the sound is absorbed at different frequencies. The sound penetrates the surface and spreads in the panels. Due to the friction with the fibers, the sound waves are converted into thermal waves (porous absorption) and kinetic energy (absorption by resonance). Because the fibers are strongly compressed, the effect is much greater than with conventional materials. The underlying acoustic structure of the felt panels makes the absorption even more efficient.

- Excellent sound absorption despite the wide frequency range
- Flexible and durable material
- Light weight
- Can be used as a composite material
- Water-repellent, oil-repellent and antibacterial
- Odorless, with a low emission of substances or odors from wall coverings and ceilings
- Fire resistant: B, S2 and D0 (low flammability) according to DIN EN 13501-1 with a wall distance of 3.15'

Tested standards: ISO 354: 2003 & ISO 11654

Measurement of sound absorption in a reverberation room (ISO 354:2003/ISO 11654)

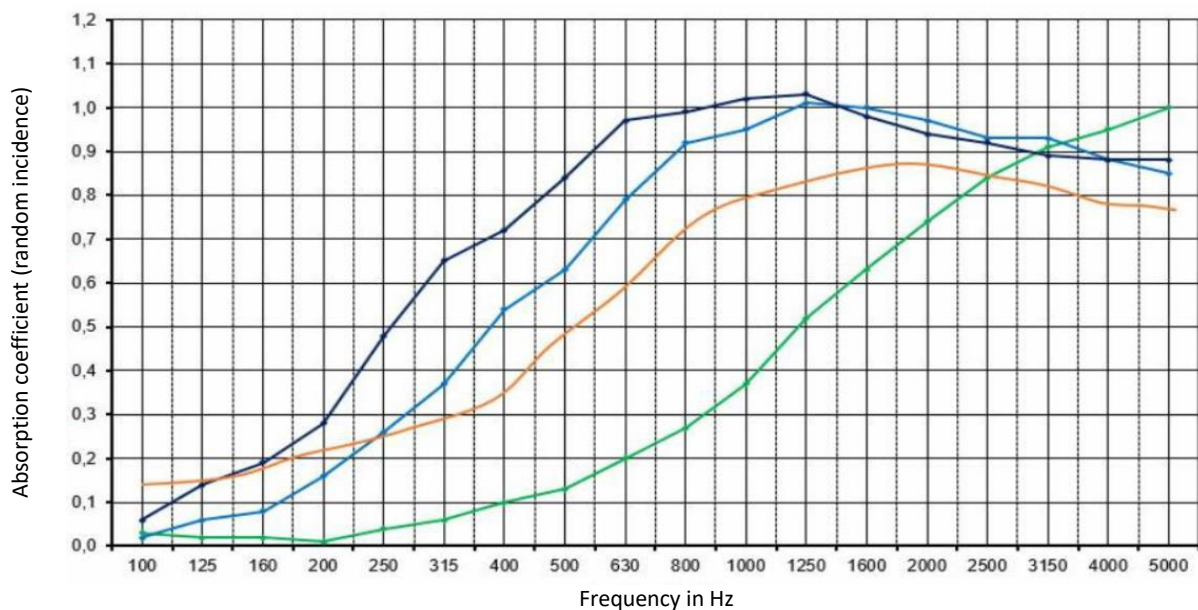

- Panel 1.57" - 4000 g/10.76 ft²
- Panel 0.98" - 4000g/10.76 ft²
- Panel 0.39" - 2800 g/10.76 ft²
- Panel 0.47" - 2800 g/10.76 ft² (with air gap)

Screens

1. Screen fixed with L-shaped profiles to the table top

7.76" under the table top



List prices

Screen size	Non-acoustic screens				Acoustic screens					
	Code	Lacquer	Veneer		Code	Upholstered in fabric				
			A	B		Cat.1	Cat.2	Cat.3	Cat.4	Cat.5
31.10" wide										
h 15.75"	WNDVA4 *	1.105	1.305	1.565	WNAVA4 *	1.275	1.370	1.470	1.565	1.675
h 19.69"	WNDVA5 *	1.275	1.525	1.860	WNAVA5 *	1.410	1.525	1.640	1.755	1.885
h 23.62"	WNDVA6 *	1.445	1.745	2.145	WNAVA6 *	1.550	1.690	1.830	1.965	2.120
38.98" wide										
h 15.75"	WNDVB4 *	1.275	1.525	1.860	WNAVB4 *	1.355	1.455	1.550	1.650	1.755
h 19.69"	WNDVB5 *	1.495	1.805	2.220	WNAVB5 *	1.520	1.630	1.745	1.860	1.990
h 23.62"	WNDVB6 *	1.705	2.080	2.585	WNAVB6 *	1.680	1.820	1.960	2.095	2.250
46.85" wide										
h 15.75"	WNDVC4 *	1.445	1.745	2.145	WNAVC4 *	1.445	1.545	1.640	1.740	1.845
h 19.69"	WNDVC5 *	1.705	2.080	2.585	WNAVC5 *	1.625	1.740	1.855	1.965	2.095
h 23.62"	WNDVC6 *	1.965	2.415	3.020	WNAVC6 *	1.810	1.950	2.090	2.225	2.380
50.79" wide										
h 15.75"	WNDVD4 *	1.535	1.860	2.295	WNAVD4 *	1.485	1.585	1.680	1.780	1.885
h 19.69"	WNDVD5 *	1.835	2.245	2.800	WNAVD5 *	1.690	1.805	1.920	2.030	2.160
h 23.62"	WNDVD6 *	2.095	2.580	3.240	WNAVD6 *	1.875	2.015	2.155	2.295	2.445
54.72" wide										
h 15.75"	WNDVE4 *	1.625	1.965	2.440	WNAVE4 *	1.525	1.625	1.720	1.820	1.925
h 19.69"	WNDVE5 *	1.925	2.360	2.945	WNAVE5 *	1.740	1.855	1.965	2.080	2.210
h 23.62"	WNDVE6 *	2.225	2.750	3.450	WNAVE6 *	1.940	2.080	2.220	2.360	2.515
58.66" wide										
h 15.75"	WNDVF4 *	1.705	2.080	2.585	WNAVF4 *	1.575	1.675	1.770	1.870	1.975
h 19.69"	WNDVF5 *	2.055	2.530	3.165	WNAVF5 *	1.795	1.910	2.025	2.140	2.270
h 23.62"	WNDVF6 *	2.360	2.910	3.670	WNAVF6 *	2.005	2.145	2.285	2.425	2.580
62.60" wide										
h 15.75"	WNDVG4 *	1.795	2.195	2.725	WNAVG4 *	1.615	1.715	1.810	1.910	2.015
h 19.69"	WNDVG5 *	2.140	2.635	3.305	WNAVG5 *	1.845	1.960	2.075	2.185	2.315
h 23.62"	WNDVG6 *	2.480	3.085	3.880	WNAVG6 *	2.075	2.210	2.350	2.490	2.645
70.47" wide										
h 15.75"	WNDVH4 *	1.965	2.415	3.020	WNAVH4 *	1.705	1.805	1.900	2.000	2.105
h 19.69"	WNDVH5 *	2.360	2.910	3.670	WNAVH5 *	1.950	2.065	2.180	2.295	2.425
h 23.62"	WNDVH6 *	2.740	3.415	4.320	WNAVH6 *	2.195	2.335	2.470	2.610	2.765

* FINISHES & CODES

1) Finish screen		3) Screen color			
	Lacquer	Veneer		Upholstered	
PL lacquered	01 lily white	Veneer A		Fabric cat. 1	Fabric cat. 4
ST upholstered	04 black	ES ash		CLW... Carlow	AR... Arco
FI veneered		NN walnut		QU... Quest	CA... Canvas 2
		NM walnut mismatched			CL... Cleo
		KE cherry		Fabric cat. 2	CR... Credo
		EK oak		MLF... Main Line Flax	SH... Shake
		EE black lacquered oak			TP... Topia
			Veneer B	Fabric cat. 3	Fabric cat. 5
			ME fossile oak	BL... Blazer	HA... Hallingdal 65
			GE fumed oak	LALO... Lobo	CT... Steelcut 3
			TE teak	ME... Meld	TR... Steelcut Trio 3
			ZE zebrano	MR... Merit	VI... Vidar 4
			PL Santos Rosewood	RE... Remix 3	
			WE wenge	RW... Re-wool	

Code example: WNDVB4PLG101 = 1.275

... = add color code

Screens

Screen fixed with L-shaped profiles to the table top

7.76" under the table top



List prices

Screen size	Non-acoustic screens				Acoustic screens					
	Code	Lacquer	Veneer		Upholstered in fabric					
			A	B	Code	Cat.1	Cat.2	Cat.3	Cat.4	Cat.5
78.35" wide										
h 15.75"	WNDVI4 *	2.140	2.635	3.305	WNAVI4 *	1.785	1.885	1.985	2.080	2.185
h 19.69"	WNDVI5 *	2.570	3.190	4.030	WNAVI5 *	2.055	2.170	2.285	2.400	2.530
h 23.62"	WNDVI6 *	3.000	3.745	4.755	WNAVI6 *	2.325	2.465	2.600	2.740	2.895
86.22" wide										
h 15.75"	WNDVJ4 *	2.310	2.855	3.595	WNAVJ4 *	1.875	1.975	2.075	2.170	2.275
h 19.69"	WNDVJ5 *	2.790	3.465	4.395	WNAVJ5 *	2.160	2.275	2.390	2.505	2.635
h 23.62"	WNDVJ6 *	3.260	4.075	5.185	WNAVJ6 *	2.455	2.595	2.735	2.870	3.025
94.09" wide										
h 15.75"	WNDVK4 *	2.480	3.085	3.880	WNAVK4 *	1.960	2.055	2.155	2.250	2.360
h 19.69"	WNDVK5 *	3.000	3.745	4.755	WNAVK5 *	2.275	2.390	2.505	2.620	2.750
h 23.62"	WNDVK6 *	3.515	4.410	5.620	WNAVK6 *	2.585	2.725	2.865	3.000	3.155
101.97" wide										
h 15.75"	WNDVL4 *	2.660	3.305	4.175	WNAVL4 *	2.050	2.145	2.245	2.340	2.445
h 19.69"	WNDVL5 *	3.215	4.030	5.115	WNAVL5 *	2.380	2.495	2.610	2.725	2.855
h 23.62"	WNDVL6 *	3.775	4.745	6.060	WNAVL6 *	2.715	2.855	2.995	3.130	3.285

* FINISHES & CODES

1) Finish screen		3) Screen color	
	Lacquer	Veneer	Upholstered
PL lacquered	01 lily white	Veneer A	Fabric cat. 1
ST upholstered	04 black	ES ash	CLW... Carlow
FI veneered		NN walnut	QU... Quest
		NM walnut mismatched	Fabric cat. 2
		KE cherry	MLF... Main Line Flax
		EK oak	
		EE black lacquered oak	Fabric cat. 3
			BL... Blazer
		Veneer B	Fabric cat. 4
		ME fossile oak	AR... Arco
		GE fumed oak	CA... Canvas 2
		TE teak	CL... Cleo
		ZE zebrano	CR... Credo
		PL Santos Rosewood	SH... Shake
		WE wenge	TP... Topia
			Fabric cat. 5
			HA... Hallingdal 65
			CT... Steelcut 3
			TR... Steelcut Trio 3
			VI... Vidar 4

Code example: WNAVI5STG4HA130 = 2.530

... = add color code

Screens

Screen built-in into the center of the table top

Pins: +1.18"



List prices

Screen size	Non-acoustic screens				Acoustic screens					
	Code	Lacquer	Veneer		Upholstered in fabric					
			A	B	Code	Cat.1	Cat.2	Cat.3	Cat.4	Cat.5
62.60" wide										
h 7.87"	WNDTG2 *	840	1.045	1.305	WNATG2 *	900	955	1.015	1.070	1.135
h 11.81"	WNDTG3 *	1.185	1.485	1.885	WNATG3 *	1.125	1.200	1.275	1.345	1.435
h 15.75"	WNDTG4 *	1.535	1.935	2.465	WNATG4 *	1.355	1.455	1.550	1.650	1.755
h 19.69"	WNDTG5 *	1.875	2.375	3.040	WNATG5 *	1.585	1.700	1.810	1.925	2.055
h 23.62"	WNDTG6 *	2.220	2.820	3.620	WNATG6 *	1.810	1.950	2.090	2.225	2.380
70.47" wide										
h 7.87"	WNATH2 *	930	1.150	1.455	WNATH2 *	950	1.005	1.060	1.120	1.185
h 11.81"	WNATH3 *	1.315	1.655	2.105	WNATH3 *	1.190	1.265	1.340	1.410	1.500
h 15.75"	WNATH4 *	1.705	2.155	2.755	WNATH4 *	1.445	1.545	1.640	1.740	1.845
h 19.69"	WNATH5 *	2.095	2.650	3.410	WNATH5 *	1.690	1.805	1.920	2.030	2.160
h 23.62"	WNATH6 *	2.480	3.155	4.060	WNATH6 *	1.935	2.075	2.210	2.350	2.505
78.35" wide										
h 7.87"	WNATI2 *	1.015	1.265	1.600	WNATI2 *	990	1.045	1.105	1.160	1.225
h 11.81"	WNATI3 *	1.445	1.820	2.325	WNATI3 *	1.260	1.330	1.405	1.480	1.565
h 15.75"	WNATI4 *	1.875	2.375	3.040	WNATI4 *	1.525	1.625	1.720	1.820	1.925
h 19.69"	WNATI5 *	2.310	2.930	3.770	WNATI5 *	1.795	1.910	2.025	2.140	2.270
h 23.62"	WNATI6 *	2.740	3.485	4.495	WNATI6 *	2.065	2.205	2.340	2.480	2.635
86.22" wide										
h 7.87"	WNATJ2 *	1.105	1.370	1.745	WNATJ2 *	1.030	1.085	1.145	1.200	1.265
h 11.81"	WNATJ3 *	1.575	1.985	2.535	WNATJ3 *	1.325	1.395	1.470	1.545	1.630
h 15.75"	WNATJ4 *	2.050	2.595	3.335	WNATJ4 *	1.615	1.715	1.810	1.910	2.015
h 19.69"	WNATJ5 *	2.530	3.205	4.135	WNATJ5 *	1.900	2.015	2.130	2.245	2.375
h 23.62"	WNATJ6 *	3.000	3.815	4.925	WNATJ6 *	2.195	2.335	2.470	2.610	2.765
94.09" wide										
h 7.87"	WNATK2 *	1.185	1.485	1.885	WNATK2 *	1.080	1.135	1.190	1.250	1.315
h 11.81"	WNATK3 *	1.705	2.155	2.755	WNATK3 *	1.390	1.460	1.535	1.610	1.700
h 15.75"	WNATK4 *	2.220	2.820	3.620	WNATK4 *	1.700	1.795	1.895	1.990	2.095
h 19.69"	WNATK5 *	2.740	3.485	4.495	WNATK5 *	2.015	2.130	2.245	2.360	2.490
h 23.62"	WNATK6 *	3.255	4.150	5.355	WNATK6 *	2.325	2.465	2.600	2.740	2.895
101.97" wide										
h 7.87"	WNATL2 *	1.275	1.600	2.030	WNATL2 *	1.120	1.175	1.235	1.290	1.355
h 11.81"	WNATL3 *	1.835	2.315	2.975	WNATL3 *	1.455	1.525	1.600	1.675	1.765
h 15.75"	WNATL4 *	2.400	3.040	3.915	WNATL4 *	1.785	1.885	1.985	2.080	2.185
h 19.69"	WNATL5 *	2.955	3.770	4.850	WNATL5 *	2.120	2.235	2.350	2.465	2.595
h 23.62"	WNATL6 *	3.515	4.485	5.795	WNATL6 *	2.455	2.595	2.735	2.870	3.025

* FINISHES & CODES

1) Finish screen		Lacquer		Veneer		3) Screen color			
				Veneer A		Fabric cat. 1		Fabric cat. 4	
PL	lacquered	01	lily white	ES	ash	CLW...	Carlow	AR...	Arco
ST	upholstered	04	black	NN	walnut	QU...	Quest	CA...	Canvas 2
FI	veneered			NM	walnut mismatched			CL...	Cleo
				KE	cherry	Fabric cat. 2		CR...	Credo
PA	aluminium color			EK	oak	MLF...	Main Line Flax	SH...	Shake
P1	lily white lacquer			EE	black lacquered oak			TP...	Topia
P4	black lacquer					Fabric cat. 3			
				Veneer B		BL...	Blazer	Fabric cat. 5	
				ME	fossile oak	LALO...	Lobo	HA...	Hallingdal 65
				GE	fumed oak	ME...	Meld	CT...	Steelcut 3
				TE	teak	MR...	Merit	TR...	Steelcut Trio 3
				ZE	zebrano	RE...	Remix 3	VI...	Vidar 4
				PL	Santos Rosewood	RW...	Re-wool		
				WE	wenge				

Code example: WNATI6STP1CT240 = 2.635

... = add color code

Screens

3. Freestanding screen

Feet: +0.59"

List prices

Screen size	Non-acoustic screens				Acoustic screens					
	Code	Lacquer	Veneer		Upholstered in fabric					
			A	B	Code	Cat.1	Cat.2	Cat.3	Cat.4	Cat.5
31.10" wide										
h 7.87"	WDOA2 *	760	860	990	WNAOA2 *	990	1.045	1.105	1.160	1.225
h 11.81"	WDOA3 *	930	1.080	1.280	WNAOA3 *	1.125	1.200	1.275	1.345	1.435
h 15.75"	WDOA4 *	1.105	1.305	1.565	WNAOA4 *	1.275	1.370	1.470	1.565	1.675
h 19.69"	WDOA5 *	1.275	1.525	1.860	WNAOA5 *	1.410	1.525	1.640	1.755	1.885
h 23.62"	WDOA6 *	1.445	1.745	2.145	WNAOA6 *	1.550	1.690	1.830	1.965	2.120
38.98" wide										
h 7.87"	WDOB2 *	840	970	1.135	WNAOB2 *	1.040	1.095	1.150	1.210	1.275
h 11.81"	WDOB3 *	1.060	1.250	1.500	WNAOB3 *	1.190	1.265	1.340	1.410	1.500
h 15.75"	WDOB4 *	1.275	1.525	1.860	WNAOB4 *	1.355	1.455	1.550	1.650	1.755
h 19.69"	WDOB5 *	1.495	1.805	2.220	WNAOB5 *	1.520	1.630	1.745	1.860	1.990
h 23.62"	WDOB6 *	1.705	2.080	2.585	WNAOB6 *	1.680	1.820	1.960	2.095	2.250
46.85" wide										
h 7.87"	WDOC2 *	930	1.080	1.280	WNAOC2 *	1.080	1.135	1.190	1.250	1.315
h 11.81"	WDOC3 *	1.190	1.410	1.715	WNAOC3 *	1.260	1.330	1.405	1.480	1.565
h 15.75"	WDOC4 *	1.445	1.745	2.145	WNAOC4 *	1.445	1.545	1.640	1.740	1.845
h 19.69"	WDOC5 *	1.705	2.080	2.585	WNAOC5 *	1.625	1.740	1.855	1.965	2.095
h 23.62"	WDOC6 *	1.965	2.415	3.020	WNAOC6 *	1.810	1.950	2.090	2.225	2.380
50.79" wide										
h 7.87"	WNDOD2 *	970	1.135	1.355	WNAOD2 *	1.095	1.150	1.210	1.265	1.330
h 11.81"	WNDOD3 *	1.275	1.525	1.860	WNAOD3 *	1.305	1.380	1.455	1.525	1.615
h 15.75"	WNDOD4 *	1.535	1.860	2.295	WNAOD4 *	1.485	1.585	1.680	1.780	1.885
h 19.69"	WNDOD5 *	1.835	2.245	2.800	WNAOD5 *	1.690	1.805	1.920	2.030	2.160
h 23.62"	WNDOD6 *	2.095	2.580	3.240	WNAOD6 *	1.875	2.015	2.155	2.295	2.445
54.72" wide										
h 7.87"	WDOE2 *	1.020	1.190	1.430	WNAOE2 *	1.120	1.175	1.235	1.290	1.355
h 11.81"	WDOE3 *	1.325	1.585	1.935	WNAOE3 *	1.325	1.395	1.470	1.545	1.630
h 15.75"	WDOE4 *	1.625	1.965	2.440	WNAOE4 *	1.525	1.625	1.720	1.820	1.925
h 19.69"	WDOE5 *	1.925	2.360	2.945	WNAOE5 *	1.740	1.855	1.965	2.080	2.210
h 23.62"	WDOE6 *	2.225	2.750	3.450	WNAOE6 *	1.940	2.080	2.220	2.360	2.515
58.66" wide										
h 7.87"	WDOF2 *	1.060	1.250	1.500	WNAOF2 *	1.145	1.200	1.260	1.315	1.380
h 11.81"	WDOF3 *	1.405	1.690	2.080	WNAOF3 *	1.370	1.445	1.520	1.590	1.680
h 15.75"	WDOF4 *	1.705	2.080	2.585	WNAOF4 *	1.575	1.675	1.770	1.870	1.975
h 19.69"	WDOF5 *	2.055	2.530	3.165	WNAOF5 *	1.795	1.910	2.025	2.140	2.270
h 23.62"	WDOF6 *	2.360	2.910	3.670	WNAOF6 *	2.005	2.145	2.285	2.425	2.580

* FINISHES & CODES

1) Finish screen		Lacquer		Veneer		3) Screen color		Upholstered	
PL	lacquered	01	lily white	Veneer A		Fabric cat. 1		Fabric cat. 4	
ST	upholstered	04	black	ES	ash	CLW...	Carlow	AR...	Arco
FI	veneered			NN	walnut	QU...	Quest	CA...	Canvas 2
				NM	walnut mismatched			CL...	Cleo
				KE	cherry	Fabric cat. 2		CR...	Credo
				EK	oak	MLF...	Main Line Flax	SH...	Shake
				EE	black lacquered oak			TP...	Topia
				Veneer B		Fabric cat. 3		Fabric cat. 5	
				ME	fossile oak	BL...	Blazer	HA...	Hallingdal 65
				GE	fumed oak	LALO...	Lobo	CT...	Steelcut 3
				TE	teak	ME...	Meld	TR...	Steelcut Trio 3
				ZE	zebrano	MR...	Merit	VI...	Vidar 4
				PL	Santos Rosewood	RE...	Remix 3		
				WE	wenge	RW...	Re-wool		

Code example: WDOE3FIV4NN = 1.585

... = add color code

Screens

Freestanding screen

Feet: +0.59"



List prices

Screen size	Non-acoustic screens				Acoustic screens					
	Code	Lacquer	Veneer		Code	Upholstered in fabric				
			A	B		Cat.1	Cat.2	Cat.3	Cat.4	Cat.5
62.60" wide										
h 7.87"	WNDOG2 *	1.105	1.305	1.565	WNAOG2 *	1.160	1.215	1.275	1.330	1.395
h 11.81"	WNDOG3 *	1.445	1.745	2.145	WNAOG3 *	1.390	1.460	1.535	1.610	1.700
h 15.75"	WNDOG4 *	1.795	2.195	2.725	WNAOG4 *	1.615	1.715	1.810	1.910	2.015
h 19.69"	WNDOG5 *	2.140	2.635	3.305	WNAOG5 *	1.845	1.960	2.075	2.185	2.315
h 23.62"	WNDOG6 *	2.480	3.085	3.880	WNAOG6 *	2.075	2.210	2.350	2.490	2.645
70.47" wide										
h 7.87"	WNDOH2 *	1.190	1.410	1.715	WNAOH2 *	1.210	1.265	1.325	1.380	1.445
h 11.81"	WNDOH3 *	1.575	1.920	2.365	WNAOH3 *	1.455	1.525	1.600	1.675	1.765
h 15.75"	WNDOH4 *	1.965	2.415	3.020	WNAOH4 *	1.705	1.805	1.900	2.000	2.105
h 19.69"	WNDOH5 *	2.360	2.910	3.670	WNAOH5 *	1.950	2.065	2.180	2.295	2.425
h 23.62"	WNDOH6 *	2.740	3.415	4.320	WNAOH6 *	2.195	2.335	2.470	2.610	2.765
78.35" wide										
h 7.87"	WNDOI2 *	1.275	1.525	1.860	WNAOI2 *	1.250	1.305	1.365	1.420	1.485
h 11.81"	WNDOI3 *	1.705	2.080	2.585	WNAOI3 *	1.520	1.590	1.665	1.740	1.830
h 15.75"	WNDOI4 *	2.140	2.635	3.305	WNAOI4 *	1.785	1.885	1.985	2.080	2.185
h 19.69"	WNDOI5 *	2.570	3.190	4.030	WNAOI5 *	2.055	2.170	2.285	2.400	2.530
h 23.62"	WNDOI6 *	3.000	3.745	4.755	WNAOI6 *	2.325	2.465	2.600	2.740	2.895
86.22" wide										
h 7.87"	WNDOJ2 *	1.365	1.630	2.005	WNAOJ2 *	1.290	1.345	1.405	1.460	1.525
h 11.81"	WNDOJ3 *	1.835	2.245	2.800	WNAOJ3 *	1.585	1.655	1.730	1.805	1.895
h 15.75"	WNDOJ4 *	2.310	2.855	3.595	WNAOJ4 *	1.875	1.975	2.075	2.170	2.275
h 19.69"	WNDOJ5 *	2.790	3.465	4.395	WNAOJ5 *	2.160	2.275	2.390	2.505	2.635
h 23.62"	WNDOJ6 *	3.260	4.075	5.185	WNAOJ6 *	2.455	2.595	2.735	2.870	3.025
94.09" wide										
h 7.87"	WNDOK2 *	1.445	1.745	2.145	WNAOK2 *	1.340	1.395	1.455	1.510	1.575
h 11.81"	WNDOK3 *	1.965	2.415	3.020	WNAOK3 *	1.650	1.720	1.795	1.870	1.960
h 15.75"	WNDOK4 *	2.480	3.085	3.880	WNAOK4 *	1.960	2.055	2.155	2.250	2.360
h 19.69"	WNDOK5 *	3.000	3.745	4.755	WNAOK5 *	2.275	2.390	2.505	2.620	2.750
h 23.62"	WNDOK6 *	3.515	4.410	5.620	WNAOK6 *	2.585	2.725	2.865	3.000	3.155
101.97" wide										
h 7.87"	WNDOL2 *	1.535	1.860	2.295	WNAOL2 *	1.380	1.435	1.495	1.550	1.615
h 11.81"	WNDOL3 *	2.095	2.580	3.240	WNAOL3 *	1.715	1.785	1.860	1.935	2.025
h 15.75"	WNDOL4 *	2.660	3.305	4.175	WNAOL4 *	2.050	2.145	2.245	2.340	2.445
h 19.69"	WNDOL5 *	3.215	4.030	5.115	WNAOL5 *	2.380	2.495	2.610	2.725	2.855
h 23.62"	WNDOL6 *	3.775	4.745	6.060	WNAOL6 *	2.715	2.855	2.995	3.130	3.285

* FINISHES & CODES

1) Finish screen		Lacquer		Veneer		3) Screen color		Upholstered	
PL	lacquered	01	lily white	Veneer A		Fabric cat. 1		Fabric cat. 4	
ST	upholstered	04	black	ES	ash	CLW...	Carlow	AR...	Arco
FI	veneered			NN	walnut	QU...	Quest	CA...	Canvas 2
				NM	walnut mismatched			CL...	Cleo
				KE	cherry	Fabric cat. 2		CR...	Credo
				EK	oak	MLF...	Main Line Flax	SH...	Shake
				EE	black lacquered oak			TP...	Topia
				Veneer B		Fabric cat. 3		Fabric cat. 5	
				ME	fossile oak	BL...	Blazer	HA...	Hallingdal 65
				GE	fumed oak	LALO...	Lobo	CT...	Steelcut 3
				TE	teak	ME...	Meld	TR...	Steelcut Trio 3
				ZE	zebrano	MR...	Merit	VI...	Vidar 4
				PL	Santos Rosewood	RE...	Remix 3		
				WE	wenge	RW...	Re-wool		

Code example: WNAOI6STV1CT240 = 2.895

... = add color code

Screens

4. Colors and materials

L-PROFILES/PINS/FEET LACQUERED



aluminium color



lily white



black

SCREEN LACQUERED

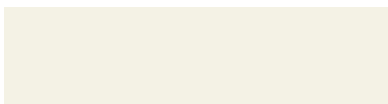

lily white



black

VENEER CATEGORY A



ash



walnut

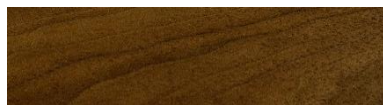

walnut mismatched



cherry



oak

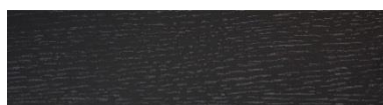

black lacquered oak

VENEER CATEGORY B



fossil oak

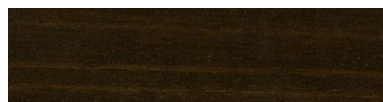

fumed oak

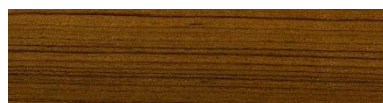

teak



zebrano



Santos Rosewood



wenge

Electrification

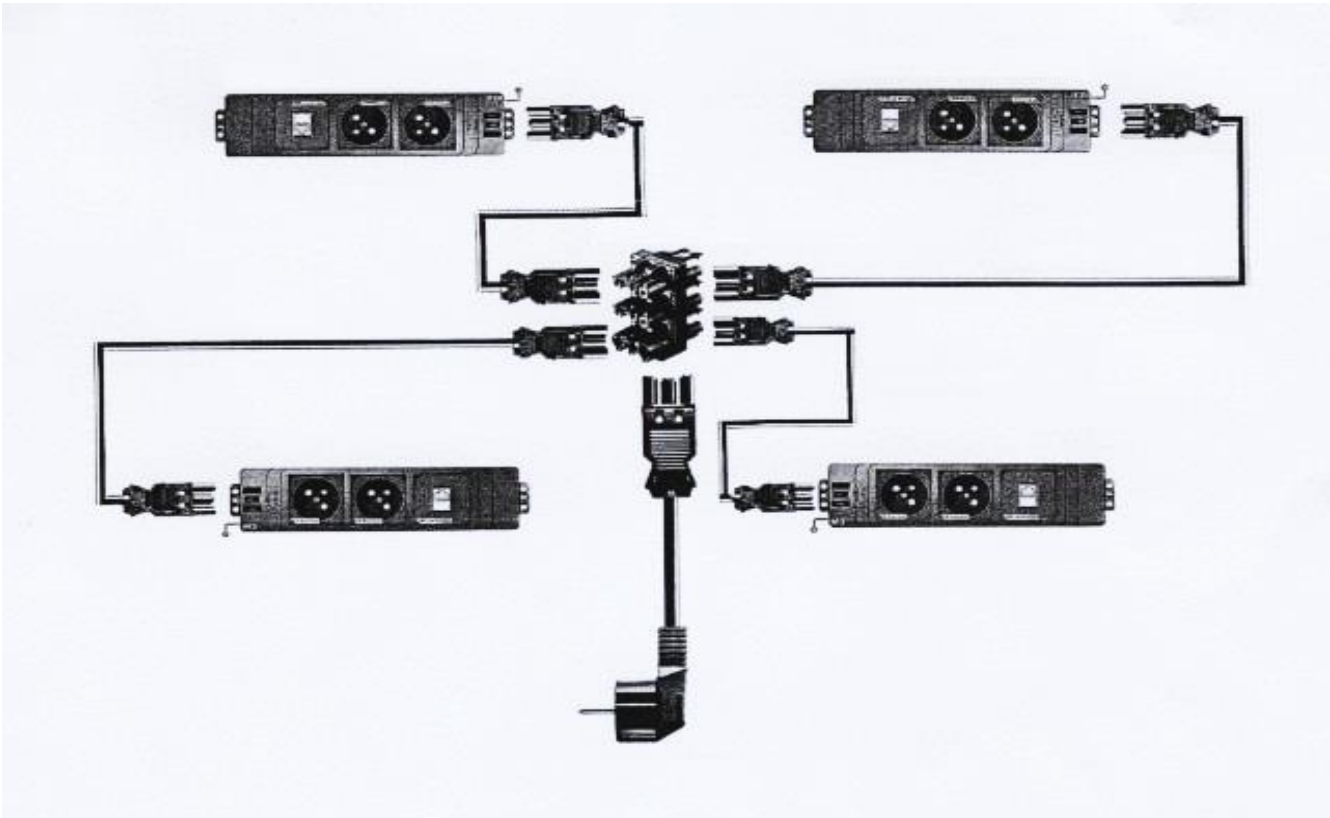

Electrification



Bulo offers grommets, power sockets and power cables for all countries.
The products in this price list are for use in the USA and Canada.
All prices in this Electrification price list are your purchase prices.

All our cables are fitted with a universal Wieland GST 18/3 plug
All socket outlets are equipped with a lead of +/- 35"
Data plugs are RJ45, cat.6, with gender changer
HDMI and VGA/audio come with a gender changer

Grommet positions are determined per collection and can be found in the price list of the collection, as well as the upcharge for the cutout. Cutouts to accommodate third party grommets on request.
Power sockets are not included in the price of the grommet, see next page.
Not suited for use with Mac Book Pro chargers.

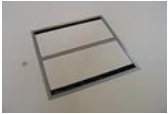
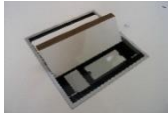
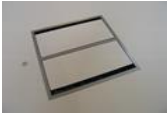
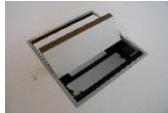

Electrification

1. Grommets

	Color/Content	Code	NET PRICES	
E. Round, diam. 2.36"				
With brush profile				
	pvc, black	CM60PLZW	10	
	pvc, white	CM60PLWI	10	
	aluminium	CM60ALU	18	
	aluminium, chrome look	CM60CH	18	
	aluminium, black	CM60ZW	21	
G. Round, diam. 3.15"				
With brush profile				
	pvc, black	CM80PLZW	11	
	pvc, white	CM80PLWI	11	
	aluminium	CM80ALU	20	
	aluminium, chrome look	CM80CH	20	
	aluminium, black	ELCEP80ALZW	23	
H. HUB				
2 layouts: HUB EL and HUB E3				
HUB EL				
Double, square grommet with brush profiles. Dim. 9.84" x 9.84"				
Both covers in the same finish as the top				
Can be equipped with 2 built-in power sockets with 2 modules each, see 2.1.				
		Frame lacquer finish:		
		lily white	ELCHUBP201	1.015
		black	ELCHUBP204	1.015
		coffee bean	ELCHUBP206	1.015
		aluminium color	ELCHUBP2AL	1.015
HUB E3				
Double, square grommet with brush profiles. Dim. 9.84" x 9.84"				
Both covers in the same finish as the top				
Can be equipped with 2 built-in power sockets with 3 modules each, see 2.2.				
		Frame lacquer finish:		
		lily white	ELCHUBP301	1.015
		black	ELCHUBP304	1.015
		coffee bean	ELCHUBP306	1.015
		aluminium color	ELCHUBP3AL	1.015

Electrification

Grommets

	Color/Content	Code	NET PRICES	
I. Go				
Rectangular grommet in lacquered metal				
Dim.: 10.83" x 6.30"				
With brush profile				
Always including socket outlet, excluding connecting/mains lead				
	Incl. 3 x power, 2 x data	EM GO3PDDUS *	500	
	Incl. 2 x power, HDMI, 2 x data	EM GO2PHDMIDDUS *	500	
	Incl. 3 x power, USB charger	EM GO3PUSBUS *	595	
	Incl. 2 x power, USB Charger, 2 x data	EM GO2PUSBDDUS *	595	
J. Normal				
Rectangular grommet with brush profile				
Dim.: 5.9" x 3.74"				
Cover in the same finish as the top				
Can be equipped with a built-in power socket with 2 modules, see 2.1.				
		Frame lacquer finish:		
		lily white	ELCEDRH01	640
		black	ELCEDRH04	640
		coffee bean	ELCEDRH06	640
		aluminium color	ELCEDRHAL	640
K/L/M/N/O. Style				
The Style grommet comes in 5 lengths				
Rectangular grommet without cover				
Always including socket outlet, excluding connecting/mains lead				
	K. Style 2	Incl. 2 x power	EMSTY2PUS *	190
		Incl. 1 x power, USB charger a/c	EMSTYPUSBUS *	320
	L. Style 3	Incl. 3 x power	EMSTY3PUS *	225
		Incl. 2 x power, 1 x tunnel	EMSTY2PTUS *	295
		Incl. 2 x power, USB charger	EMSTY2PUSBUS *	400
	M. Style 4	Incl. 4 x power	EMSTY4PUS *	265
	Incl. 2 x power, 1 x tunnel, 2 x data	EMSTY2PTDDUS *	330	
	Incl. 2 x power, USB charger a/c, 2 x data	EMSTY2PUSBDDUS *	500	
N. Style 5	Incl. 5 x power	EMSTY5PUS *	305	
	Incl. 3 x power, 1 x tunnel, 2 x data	EMSTY3PTDDUS *	395	
	Incl. 3 x power, USB charger a/c, 2 x data	EMSTY3PUSBDDUS *	580	
O. Style 6	Incl. 6 x power	EMSTY6PUS *	345	
	Incl. 4 x power, 1 x tunnel, 2 x data	EMSTY4PTDDUS *	460	
	Incl. 4 x power, USB charger a/c, 2 x data	EMSTY4PUSBDDUS *	665	



* FINISHES & CODES

Grommet color

W	white
B	black

Electrification

Grommets

	Color/Content	Code	NET PRICES
X. XXL			
Rectangular grommet with brush profile			
Dim.: 8.86" x 3.74"			
Cover in the same finish as the top			
Can be equipped with a built-in power socket with 3 modules, see 2.2.			
	Frame lacquer finish:		
	lily white	ELCEDRH01XXL	750
	black	ELCEDRH04XXL	750
	coffee bean	ELCEDRH06XXL	750
	aluminium color	ELCEDRH09XXL	750
Y. Point			
Diam. 3.15"			
Grommet without cover			
	Incl. 1 x power	EMPNTPLUS *	120
	Incl. 1 x power, 2 x data	EMPNTPDDUS *	160
	Incl. 1 x power, USB Cbarger a, 1 x data	EMPNTPUSBADUS *	310
	Incl. 1 x power, USB Cbarger c, 1 x data	EMPNTPUSBCDUS *	310
Z. Top Access			
Dim.: 11.61" x 4.6"			
With brush profile			
For cable guidance only. Not equipped to hold a socket outlet.			
	black, ral9005	CM TOP ACCES ZW	110
	white, ral9016	CM TOP ACCES WI	115

* FINISHES & CODES

Grommet color

W	white
B	black

Electrification

2. Power sockets to build into a grommet

3. Underdesk power sockets

Code

NET PRICES

Grommets to be ordered separately, see previous pages.

Options for each module: 1 x power

1 or 2 x data RJ45, cat. 6

2 x USB charger

1 x HDMI





1 x VGA

other on request

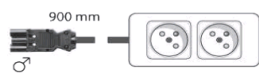

All power sockets come with a connecting lead of +/- 35" with male Wieland GST18/3 plug

Data, HDMI and VGA/audio come with a gender changer

2.1. Power socket for Normal, HUB EL and KEI organic meeting table grommet, with 2 modules

	2 x power	EM MEB2USPP *	155
	1 x power + 2 x USB charger a/c	EM MEB2USPUSB *	285
	1 x power + 1 x data RJ45, cat. 6	EM MEB2USPDGC *	180
	1 x power + 2 x data RJ45, cat. 6	EM MEB2USPDDGC *	205

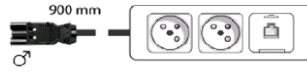
2.2. Power socket for XXL and HUB E3 grommet, with 3 modules

	3 x power	EM MEB3USPPP *	185
	2 x power + 1 x data RJ45, cat. 6	EM MEB3USPPDGC *	215
	2 x power + 2 x data RJ45, cat. 6	EM MEB3USPPDDGC *	240
	2 x power + 2 x USB charger a/c	EM MEB3USPPUSB *	385
	2 x power + VGA/audio	EM MEB3USPPVGA *	335
	1 x power + VGA/audio + 1 x data RJ45, cat. 6	EM MEB3USPVGADGC *	360
	1 x power + VGA/audio + 2 x data RJ45, cat. 6	EM MEB3USPVGADDGC *	385
	1 x power + VGA/audio + HDMI	EM MEB3USPVGAHDMI *	385
	2 x power + HDMI	EM MEB3USPPHDMI *	235

3. Underdesk power sockets, black with orange inlay

Without cables, with Wieland GST18/3 connections on both sides to allow a daisy chain

	3 x power	EMPBW3PUS	101
	4 x power	EMPBW4PUS	135

* FINISHES & CODES















Socket color

W white

B black

Electrification

4. Cables, connectors & clamps

		Code	NET PRICES
4.1. Mains leads with safety fuse			
	39" long	CMAKW1MUS	80
	79" long	CMAKW2MUS	105
	118" long	CMAKW3MUS	130
	157" long	CMAKW4MUS	150
	197" long	CMAKW5MUS	170
4.2. Connecting leads			
	39" long	CMKKW1M	22
	79" long	CMKKW2M	27
	118" long	CMKKW3M	29
	157" long	CMKKW4M	35
4.3. Splitters			
	2 connections (via socket)	CMVBKW12	22
	3 connections (1 in, 3 out)	CMVBKW13	26
	5 connections (1 in, 5 out)	CMVBKW15	33
4.4. Cable clamps			
	Single cable clamp 4.13", grey	ELCKK02	22
	Double cable clamp 8.26", black	ELCKK04	22

Electrification

5. Cable management

	Finish	Code	NET PRICES
5.1. Cable net (not suited for H2O, grID and Senses, see the respective price list)			
Dim.: w 35.43" x d 16.14"	grey	ELCCN09UN08	215
	black	ELCCN09UN04	215
5.2. Flextube cable sleeve (1.26")			
	Black		
	39" long	CMTFFT01Z	27
	79" long	CMTFFT02Z	53
	118" long	CMTFFT03Z	77
	157" long	CMTFFT04Z	102
	197" long	CMTFFT05Z	130
	White		
	39" long	CMTFFT01W	27
	79" long	CMTFFT02W	53
	118" long	CMTFFT03W	77
157" long	CMTFFT04W	102	
197" long	CMTFFT05W	130	

Electrification

6. CPU holders

	Model	CPU sizes	Finish	Code	NET PRICES
6. CPU holders					
Underdesk adaptable CPU holder, incl. wood screws					
Width and height of the CPU holder are adjustable.					
If a frame or a beam make normal suspension impossible, a height adapter can be added					
CPU holder without adapter					
	Standard	h 9.84" - 17.72" w 2.36" - 6.30"	black	ERG INT-CPU-STD B	175
			silver	ERG INT-CPU-STD S	175
			white	ERG INT-CPU-STD W	175
	Big	h 11.81" - 23.62" w 3.54" - 9.84"	black	ERG INT-CPU-BIG B	175
			silver	ERG INT-CPU-BIG S	175
			white	ERG INT-CPU-BIG W	175
	Small	h 6.69" - 12.20" w 1.18" - 3.94"	black	ERG INT-CPU-SMA B	175
			silver	ERG INT-CPU-SMA S	175
			white	ERG INT-CPU-SMA W	175
CPU holders with height adapter (U-shaped bracket to lower the CPU holder, eg. for the H2O collection)					
	Standard	h 9.84" - 17.72" w 2.36" - 6.30"	black	ERG INT-CPU-STD B A	235
			silver	ERG INT-CPU-STD S A	235
			white	ERG INT-CPU-STD W A	235
	Big	h 11.81" - 23.62" w 3.54" - 9.84"	black	ERG INT-CPU-BIG B A	235
			silver	ERG INT-CPU-BIG S A	235
			white	ERG INT-CPU-BIG W A	235
	Small	h 6.69" - 12.20" w 1.18" - 3.94"	black	ERG INT-CPU-SMA B A	235
			silver	ERG INT-CPU-SMA S A	235
			white	ERG INT-CPU-SMA W A	235

Modular Storage Units

by BuloDesign



Modular Storage Units

by BuloDesign

Storage units with hinged doors.

Row of multiple units with casing to create the look of being a unit in one piece.

Shelves included

New sizes as from 1st January 2023

DIMENSIONS

Width:

- single unit - 36.69"
- double unit - 72.36"
- row of 3 units - 108.07"
- row of 4 units - 143.82"
- row of 5 units - 183.07"
- row of 6 units - 215.24"

Depth: 18.90"

Height:

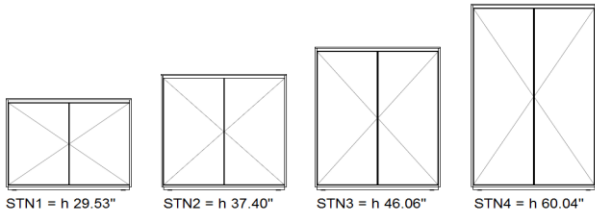

- 29.53" - 1 binder high
 - 37.40" - 2 binders high
 - 46.06" - 3 binders high
 - 60.04" - 4 binders high
- } 1 door high

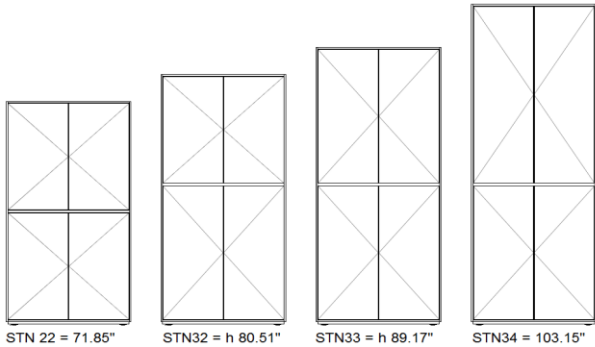

- 71.85" - 4 binders high
 - 80.51" - 5 binders high
 - 89.17" - 6 binders high
 - 103.15" - 7 binders high
- } 2 doors above each other

TOPS

- Top of single unit in one piece
- Top of double unit in one piece
- Top of row of 3 units in one piece
- Top of row of 4 units: in 2 parts
- Top of row of 5 units: in 2 parts
- Top of row of 6 units: in 3 parts

LOCK: without lock or with black cylinder lock and 2 keys.

ADDITIONAL FINISH OF THE BACK FOR FREESTANDING UNITS

We advise to choose a finish for the back when the unit is placed freestanding in the room. Preferably this is the same finish as the casing. To be specified within the code of the unit. Upcharge for finished back, see page 199

A unit placed with its back against a wall does not require a back finish.

CODE COMPOSITION EXAMPLE:

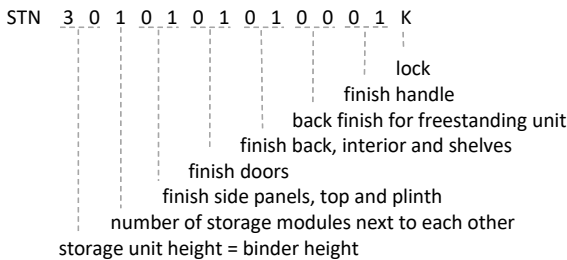

Modular Storage Units

1. Melamine or Fenix hpl

List prices

1.1. Low and middle high storage units

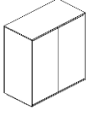
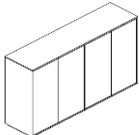
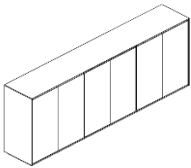
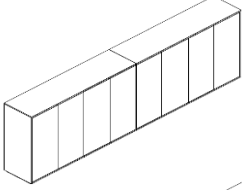
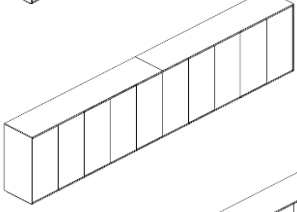
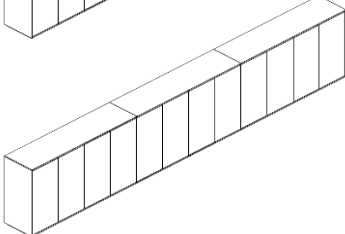
	Code	Melamine	* 1) + 2) in Fenix hpl	
	Single unit w 36.69" x d 18.90"			
		STN101 *	2.505	3.050
		STN201 *	2.580	3.165
		STN301 *	2.735	3.385
		STN401 *	2.815	3.655
	Double unit w 72.36" x d 18.90"			
		STN102 *	4.550	5.545
		STN202 *	4.665	5.715
		STN302 *	4.960	6.115
		STN402 *	5.095	6.490
	Row of 3 units w 108.07" x d 18.90"			
		STN103 *	6.645	8.110
		STN203 *	6.800	8.340
		STN303 *	7.230	8.920
		STN403 *	7.425	9.400
	Row of 4 units w 143.82" x d 18.90"			
		STN104 *	8.740	10.670
		STN204 *	8.935	10.955
		STN304 *	9.505	11.715
		STN404 *	9.760	12.300
	Row of 5 units w 179.53" x d 18.90"			
		STN105 *	10.860	13.285
		STN205 *	11.095	13.630
		STN305 *	11.805	14.565
		STN405 *	12.115	15.260
	Row of 6 units w 215.24" x d 18.90"			
		STN106 *	12.975	15.845
		STN206 *	13.255	16.245
		STN306 *	14.100	17.360
		STN406 *	14.470	18.160

* FINISHES & CODES

1) Casing (side panels, top panel and plinth)

01 lily white melamine	F4 hpl Fenix black
04 black melamine	F6 hpl Fenix blu fes
	F7 hpl Fenix verde comodo
F1 hpl Fenix white	F8 hpl Fenix beige luxor
F2 hpl Fenix beige Arizona	F9 hpl Fenix rosso jaipur
F3 hpl Fenix grigio bromo	

2) Doors

01 lily white melamine	F4 hpl Fenix black
04 black melamine	F6 hpl Fenix blu fes
	F7 hpl Fenix verde comodo
F1 hpl Fenix white	F8 hpl Fenix beige luxor
F2 hpl Fenix beige Arizona	F9 hpl Fenix rosso jaipur
F3 hpl Fenix grigio bromo	

3) Back, interior and shelves

01 lily white melamine	04 black melamine
------------------------	--------------------------

4) Additional finish of the back

00 no	F3 hpl Fenix grigio bromo (+)
	F4 hpl Fenix black (+)
01 lily white melamine (+)	F6 hpl Fenix blu fes (+)
04 black melamine (+)	F7 hpl Fenix verde comodo (+)
F1 hpl Fenix white (+)	F8 hpl Fenix beige luxor (+)
F2 hpl Fenix beige Arizona (+)	F9 hpl Fenix rosso jaipur (+)

(+) With upcharge, see p.199

5) Integrated handle

01 lily white melamine	04 black melamine
------------------------	--------------------------

6) Lock

0 without lock	K black cylinder lock (2 keys)
----------------	---------------------------------------



Code example: STN301F4F404F404K = 3.895

Modular Storage Units

Melamine or Fenix hpl

List prices

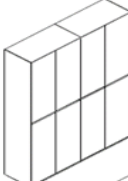
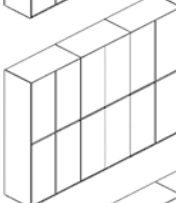
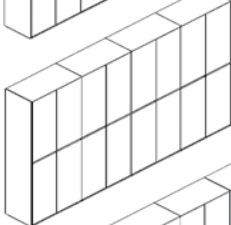
1.2. High storage units

	Code	Melamine	* 1) + 2) in Fenix hpl
	Single unit w 36.69" x d 18.90"		
	h 71.85"	STN221 *	4.255 5.585
	h 80.51"	STN321 *	4.330 5.855
	h 89.17"	STN331 *	4.435 6.080
	Double unit w 72.36" x d 18.90"		
	h 71.85"	STN222 *	8.105 10.355
	h 80.51"	STN322 *	8.240 10.800
	h 89.17"	STN332 *	8.445 11.170
	Row of 3 units w 108.07" x d 18.90"		
	h 71.85"	STN223 *	11.950 15.195
	h 80.51"	STN323 *	12.155 15.820
	h 89.17"	STN333 *	12.455 16.325
	Row of 4 units w 143.82" x d 18.90"		
	h 71.85"	STN224 *	15.795 20.025
	h 80.51"	STN324 *	16.065 20.835
	h 89.17"	STN334 *	16.465 21.480
	Row of 5 units w 179.53" x d 18.90"		
	h 71.85"	STN225 *	19.645 24.915
	h 80.51"	STN325 *	19.980 25.905
	h 89.17"	STN335 *	20.475 26.685
	Row of 6 units w 215.24" x d 18.90"		
	h 71.85"	STN226 *	23.490 29.750
	h 80.51"	STN326 *	23.890 30.915
	h 89.17"	STN336 *	24.485 31.835
	h 103.15"	STN346 *	25.520 33.150

* FINISHES & CODES

1) Casing (side panels, top panel and plinth)	
01 lily white melamine	F4 hpl Fenix black
04 black melamine	F6 hpl Fenix blu fes
	F7 hpl Fenix verde comodoro
F1 hpl Fenix white	F8 hpl Fenix beige luxor
F2 hpl Fenix beige Arizona	F9 hpl Fenix rosso jaipur
F3 hpl Fenix grigio bromo	
2) Doors	
01 lily white melamine	F4 hpl Fenix black
04 black melamine	F6 hpl Fenix blu fes
	F7 hpl Fenix verde comodoro
F1 hpl Fenix white	F8 hpl Fenix beige luxor
F2 hpl Fenix beige Arizona	F9 hpl Fenix rosso jaipur
F3 hpl Fenix grigio bromo	

3) Back, interior and shelves	
01 lily white melamine	04 black melamine
4) Additional finish of the back	
00 no	F3 hpl Fenix grigio bromo (+)
	F4 hpl Fenix black (+)
01 lily white melamine (+)	F6 hpl Fenix blu fes (+)
04 black melamine (+)	F7 hpl Fenix verde comodoro (+)
F1 hpl Fenix white (+)	F8 hpl Fenix beige luxor (+)
F2 hpl Fenix beige Arizona (+)	F9 hpl Fenix rosso jaipur (+)

(+) With upcharge, see p.199

5) Integrated handle	
01 lily white melamine	04 black melamine
6) Lock	
0 without lock	K black cylinder lock (2 keys)

Code example: STN333F4F404F404K = 18.455

Modular Storage Units

2. Casing in melamine, doors in veneer

2.1. Low and middle high storage units

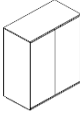
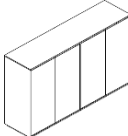
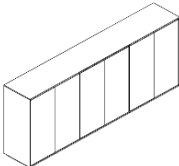
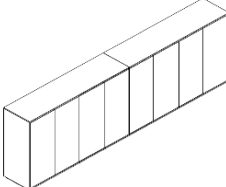
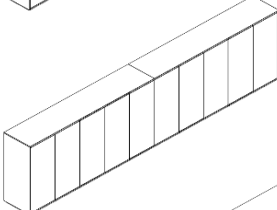
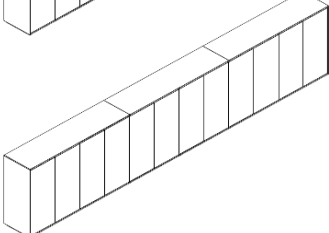
	Code	Veneer cat. A	List prices Veneer cat. B
	Single unit w 36.69" x d 18.90"		
	h 29.53"	STN101 *	3.240
	h 37.40"	STN201 *	3.525
	h 46.06"	STN301 *	3.900
	h 60.04"	STN401 *	4.340
	Double unit w 72.36" x d 18.90"		
	h 29.53"	STN102 *	6.015
	h 37.40"	STN202 *	6.555
	h 46.06"	STN302 *	7.290
	h 60.04"	STN402 *	8.145
	Row of 3 units w 108.07" x d 18.90"		
	h 29.53"	STN103 *	8.845
	h 37.40"	STN203 *	9.635
	h 46.06"	STN303 *	10.730
	h 60.04"	STN403 *	12.000
	Row of 4 units w 143.82" x d 18.90"		
	h 29.53"	STN104 *	11.675
	h 37.40"	STN204 *	12.715
	h 46.06"	STN304 *	14.165
	h 60.04"	STN404 *	15.855
	Row of 5 units w 179.53" x d 18.90"		
	h 29.53"	STN105 *	14.525
	h 37.40"	STN205 *	15.820
	h 46.06"	STN305 *	17.630
	h 60.04"	STN405 *	19.735
	Row of 6 units w 215.24" x d 18.90"		
	h 29.53"	STN106 *	17.380
	h 37.40"	STN206 *	18.925
	h 46.06"	STN306 *	21.095
	h 60.04"	STN406 *	23.615

* FINISHES & CODES

1) Casing (side panels, top panel and plinth)		4) Additional finish of the back	
01 lily white melamine	04 black melamine	00 no	
2) Doors		01 lily white melamine (+)	04 black melamine (+)
Veneer cat. A	Veneer cat. B	(+) With upcharge, see p.199	
ES ash	ME fossile oak	5) Integrated handle	
NN walnut	GE fumed oak	01 lily white melamine	04 black melamine
NM walnut, mismatched	TE teak	6) Lock	
KE cherry	ZE zebrano	0 without lock	K black cylinder lock (2 keys)
EK European oak	PL Santos rosewood		
EE black lacquered oak	WE wenge		
3) Back, interior and shelves			
01 lily white melamine	04 black melamine		



Code example: STN10104NN0004K = 3.240

Modular Storage Units

Casing in melamine, doors in veneer

2.2. High storage units

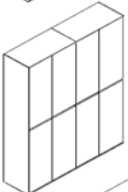
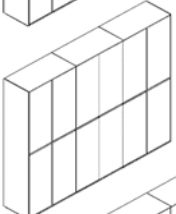
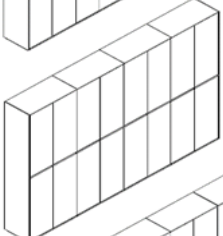
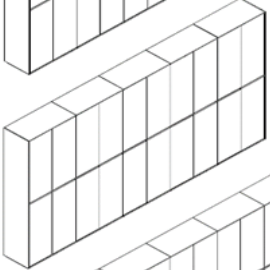
List prices

	Code	Veneer cat. A	Veneer cat. B
	Single unit w 36.69" x d 18.90"		
	h 71.85"	STN221 *	6.840
	h 80.51"	STN321 *	7.060
	h 89.17"	STN331 *	7.445
	h 103.15"	STN341 *	8.200
	Double unit w 72.36" x d 18.90"		
	h 71.85"	STN222 *	13.270
	h 80.51"	STN322 *	13.705
	h 89.17"	STN332 *	14.460
	h 103.15"	STN342 *	15.920
	Row of 3 units w 108.07" x d 18.90"		
	h 71.85"	STN223 *	19.700
	h 80.51"	STN323 *	20.345
	h 89.17"	STN333 *	21.480
	h 103.15"	STN343 *	23.635
	Row of 4 units w 143.82" x d 18.90"		
	h 71.85"	STN224 *	26.130
	h 80.51"	STN324 *	26.985
	h 89.17"	STN334 *	28.495
	h 103.15"	STN344 *	31.355
	Row of 5 units w 179.53" x d 18.90"		
	h 71.85"	STN225 *	32.560
	h 80.51"	STN325 *	33.630
	h 89.17"	STN335 *	35.510
	h 103.15"	STN345 *	39.075
	Row of 6 units w 215.24" x d 18.90"		
	h 71.85"	STN226 *	38.990
	h 80.51"	STN326 *	40.270
	h 89.17"	STN336 *	42.530
	h 103.15"	STN346 *	46.790

* FINISHES & CODES

1) Casing (side panels, top panel and plinth)		4) Additional finish of the back	
01 lily white melamine	04 black melamine	00 no	
2) Doors		01 lily white melamine (+)	04 black melamine (+)
Veneer cat. A	Veneer cat. B	(+) With upcharge, see p.199	
ES ash	ME fossile oak	5) Integrated handle	
NN walnut	GE fumed oak	01 lily white melamine	04 black melamine
NM walnut, mismatched	TE teak	6) Lock	
KE cherry	ZE zebrano	0 without lock	K black cylinder lock (2 keys)
EK European oak	PL Santos rosewood		
EE black lacquered oak	WE wenge		
3) Back, interior and shelves			
01 lily white melamine	04 black melamine		

Code example: STN32504NN040004K = 27.315

Modular Storage Units

3. Casing in veneer, doors in melamine

3.1. Low and middle high storage units

List prices

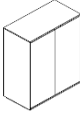
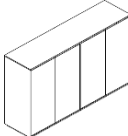
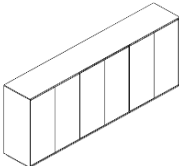
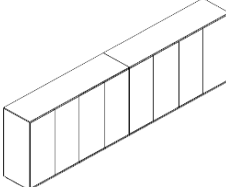
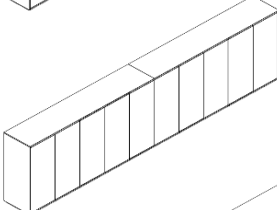
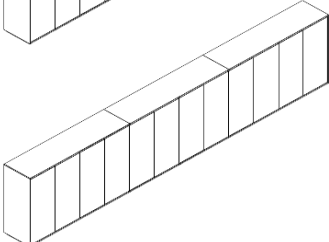
		Code	Veneer cat. A	Veneer cat. B
	Single unit			
	w 36.69" x d 18.90"			
	h 29.53"	STN101 *	3.320	3.790
	h 37.40"	STN201 *	3.605	4.185
	h 46.06"	STN301 *	3.970	4.695
	Double unit			
	w 72.36" x d 18.90"			
	h 29.53"	STN102 *	5.365	5.840
	h 37.40"	STN202 *	5.690	6.270
	h 46.06"	STN302 *	6.195	6.920
	Row of 3 units			
	w 108.07" x d 18.90"			
	h 29.53"	STN103 *	7.460	7.930
	h 37.40"	STN203 *	7.825	8.405
	h 46.06"	STN303 *	8.470	9.195
	Row of 4 units			
	w 143.82" x d 18.90"			
	h 29.53"	STN104 *	9.555	10.025
	h 37.40"	STN204 *	9.960	10.540
	h 46.06"	STN304 *	10.745	11.470
	Row of 5 units			
	w 179.53" x d 18.90"			
	h 29.53"	STN105 *	11.675	12.145
	h 37.40"	STN205 *	12.120	12.700
	h 46.06"	STN305 *	13.040	13.770
	Row of 6 units			
	w 215.24" x d 18.90"			
	h 29.53"	STN106 *	13.790	14.265
	h 37.40"	STN206 *	14.280	14.860
	h 46.06"	STN306 *	15.340	16.065
	h 60.04"	STN406 *	16.105	17.070

* FINISHES & CODES

1) Casing (side panels, top panel and plinth)		4) Additional finish of the back	
Veneer cat. A	Veneer cat. B	00 no	
ES ash	ME fossile oak	Veneer cat. A	Veneer cat. B
NN walnut	GE fumed oak	ES ash (+)	ME fossile oak (+)
NM walnut, mismatched	TE teak	NN walnut (+)	GE fumed oak (+)
KE cherry	ZE zebrano	NM walnut, mismatched (+)	TE teak (+)
EK European oak	PL Santos rosewood	KE cherry (+)	ZE zebrano (+)
EE black lacquered oak	WE wenge	EK European oak (+)	PL Santos rosewood (+)
		EE black lacquered oak (+)	WE wenge (+)
2) Doors		5) Integrated handle	
01 lily white melamine	04 black melamine	01 lily white melamine	04 black melamine
3) Back, interior and shelves		6) Lock	
01 lily white melamine	04 black melamine	0 without lock	K black cylinder lock (2 keys)



Code example: STN204EK010100010 = 9.960

Modular Storage Units

Casing in veneer, doors in melamine

3.2. High storage units

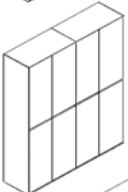
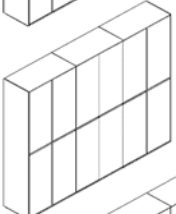
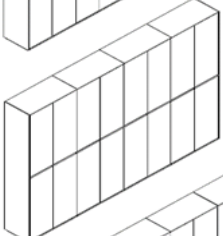
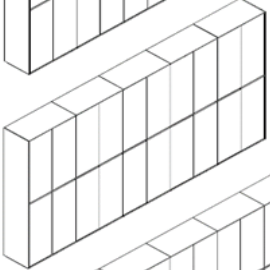
List prices

	Code	Veneer cat. A	Veneer cat. B
	Single unit w 36.69" x d 18.90"		
	h 71.85"	STN221 *	6.195
	h 80.51"	STN321 *	6.400
	h 89.17"	STN331 *	6.765
	h 103.15"	STN341 *	7.445
	Double unit w 72.36" x d 18.90"		
	h 71.85"	STN222 *	10.045
	h 80.51"	STN322 *	10.310
	h 89.17"	STN332 *	10.775
	h 103.15"	STN342 *	11.615
	Row of 3 units w 108.07" x d 18.90"		
	h 71.85"	STN223 *	13.890
	h 80.51"	STN323 *	14.225
	h 89.17"	STN333 *	14.785
	h 103.15"	STN343 *	15.790
	Row of 4 units w 143.82" x d 18.90"		
	h 71.85"	STN224 *	17.735
	h 80.51"	STN324 *	18.135
	h 89.17"	STN334 *	18.795
	h 103.15"	STN344 *	19.960
	Row of 5 units w 179.53" x d 18.90"		
	h 71.85"	STN225 *	21.585
	h 80.51"	STN325 *	22.050
	h 89.17"	STN335 *	22.805
	h 103.15"	STN345 *	24.135
	Row of 6 units w 215.24" x d 18.90"		
	h 71.85"	STN226 *	25.430
	h 80.51"	STN326 *	25.960
	h 89.17"	STN336 *	26.815
	h 103.15"	STN346 *	28.305

* FINISHES & CODES

1) Casing (side panels, top panel and plinth)		4) Additional finish of the back	
Veneer cat. A	Veneer cat. B	00 no	Veneer cat. B
ES ash	ME fossile oak	Veneer cat. A	Veneer cat. B
NN walnut	GE fumed oak	ES ash (+)	ME fossile oak (+)
NM walnut, mismatched	TE teak	NN walnut (+)	GE fumed oak (+)
KE cherry	ZE zebrano	NM walnut, mismatched (+)	TE teak (+)
EK European oak	PL Santos rosewood	KE cherry (+)	ZE zebrano (+)
EE black lacquered oak	WE wenge	EK European oak (+)	PL Santos rosewood (+)
		EE black lacquered oak (+)	WE wenge (+)
2) Doors		5) Integrated handle	
01 lily white melamine	04 black melamine	01 lily white melamine	04 black melamine
3) Back, interior and shelves		6) Lock	
01 lily white melamine	04 black melamine	0 without lock	K black cylinder lock (2 keys)

Code example: STN322EK010100010 = 10.310

Modular Storage Units

4. Casing and doors in veneer

4.1. Low and middle high storage units

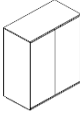
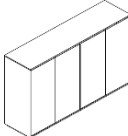
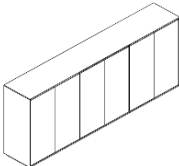
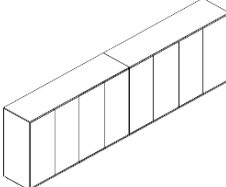
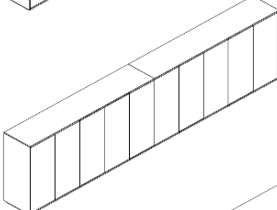
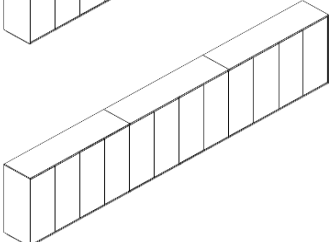
		Code	Veneer cat. A	List prices Veneer cat. B
	Single unit			
	w 36.69" x d 18.90"			
	h 29.53"	STN101 *	4.055	5.005
	h 37.40"	STN201 *	4.550	5.740
	h 46.06"	STN301 *	5.135	6.565
	Double unit			
	w 72.36" x d 18.90"			
	h 29.53"	STN102 *	6.830	8.265
	h 37.40"	STN202 *	7.580	9.385
	h 46.06"	STN302 *	8.525	10.655
	Row of 3 units			
	w 108.07" x d 18.90"			
	h 29.53"	STN103 *	9.660	11.575
	h 37.40"	STN203 *	10.665	13.075
	h 46.06"	STN303 *	11.965	14.795
	Row of 4 units			
	w 143.82" x d 18.90"			
	h 29.53"	STN104 *	12.490	14.885
	h 37.40"	STN204 *	13.745	16.765
	h 46.06"	STN304 *	15.405	18.935
	Row of 5 units			
	w 179.53" x d 18.90"			
	h 29.53"	STN105 *	15.340	18.220
	h 37.40"	STN205 *	16.850	20.485
	h 46.06"	STN305 *	18.870	23.100
	Row of 6 units			
	w 215.24" x d 18.90"			
	h 29.53"	STN106 *	18.195	21.550
	h 37.40"	STN206 *	19.955	24.200
	h 46.06"	STN306 *	22.335	27.265
	h 60.04"	STN406 *	25.250	31.590

* FINISHES & CODES

1) Casing (side panels, top panel and plinth)		3) Back, interior and shelves	
Veneer cat. A	Veneer cat. B	01 lily white melamine	04 black melamine
ES ash	ME fossile oak		
NN walnut	GE fumed oak	4) Additional finish of the back	
NM walnut, mismatched	TE teak	00 no	
KE cherry	ZE zebrano	Veneer cat. A	Veneer cat. B
EK European oak	PL Santos rosewood	ES ash (+)	ME fossile oak (+)
EE black lacquered oak	WE wenge	NN walnut (+)	GE fumed oak (+)
		NM walnut, mismatched (+)	TE teak (+)
2) Doors		KE cherry (+)	ZE zebrano (+)
Veneer cat. A	Veneer cat. B	EK European oak (+)	PL Santos rosewood (+)
ES ash	ME fossile oak	EE black lacquered oak (+)	WE wenge (+)
NN walnut	GE fumed oak	(+) With upcharge, see p.199	
NM walnut, mismatched	TE teak	5) Integrated handle	
KE cherry	ZE zebrano	01 lily white melamine	04 black melamine
EK European oak	PL Santos rosewood		
EE black lacquered oak	WE wenge	6) Lock	
		0 without lock	K black cylinder lock (2 keys)



Code example: STN206GE040004K = 24.200

Modular Storage Units

Casing and doors in veneer

4.2. High storage units

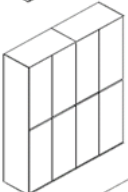
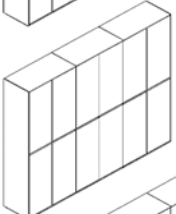
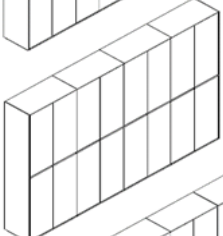
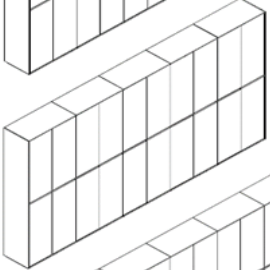
List prices

	Code	Veneer cat. A	Veneer cat. B
	Single unit w 36.69" x d 18.90"		
	h 71.85"	STN221 *	7.665
	h 80.51"	STN321 *	7.865
	h 89.17"	STN331 *	8.395
	h 103.15"	STN341 *	9.390
	Double unit w 72.36" x d 18.90"		
	h 71.85"	STN222 *	12.975
	h 80.51"	STN322 *	13.245
	h 89.17"	STN332 *	14.035
	Row of 3 units w 108.07" x d 18.90"		
	h 71.85"	STN223 *	18.290
	h 80.51"	STN323 *	18.625
	h 89.17"	STN333 *	19.675
	Row of 4 units w 143.82" x d 18.90"		
	h 71.85"	STN224 *	23.605
	h 80.51"	STN324 *	24.005
	h 89.17"	STN334 *	25.315
	Row of 5 units w 179.53" x d 18.90"		
	h 71.85"	STN225 *	28.920
	h 80.51"	STN325 *	29.385
	h 89.17"	STN335 *	30.955
	Row of 6 units w 215.24" x d 18.90"		
	h 71.85"	STN226 *	34.230
	h 80.51"	STN326 *	34.760
	h 89.17"	STN336 *	36.595
	h 103.15"	STN346 *	39.995

* FINISHES & CODES

1) Casing (side panels, top panel and plinth)		3) Back, interior and shelves	
Veneer cat. A	Veneer cat. B	01 lily white melamine	04 black melamine
ES ash	ME fossile oak	4) Additional finish of the back	
NN walnut	GE fumed oak	00 no	
NM walnut, mismatched	TE teak	Veneer cat. A	Veneer cat. B
KE cherry	ZE zebrano	ES ash (+)	ME fossile oak (+)
EK European oak	PL Santos rosewood	NN walnut (+)	GE fumed oak (+)
EE black lacquered oak	WE wenge	NM walnut, mismatched (+)	TE teak (+)
2) Doors		KE cherry (+)	ZE zebrano (+)
Veneer cat. A	Veneer cat. B	EK European oak (+)	PL Santos rosewood (+)
ES ash	ME fossile oak	EE black lacquered oak (+)	WE wenge (+)
NN walnut	GE fumed oak	(+) With upcharge, see p.199	
NM walnut, mismatched	TE teak	5) Integrated handle	
KE cherry	ZE zebrano	01 lily white melamine	04 black melamine
EK European oak	PL Santos rosewood	6) Lock	
EE black lacquered oak	WE wenge	0 without lock	K black cylinder lock (2 keys)

Code example: STN222GEGE040004K = 16.325

Modular Storage Units

5. Upcharges finished back for freestanding units

	For code	Melamine	Fenix hpl	Veneer cat. A	Veneer cat. B	List prices
Single unit						
w 36.69" x d 18.90"						
h 29.53"	STN101	345	425	605		515
h 37.40"	STN201	355	460	640		550
h 46.06"	STN301	385	510	710		615
h 60.04"	STN401	445	565	795		680
h 71.85"	STN221	485	630	885		755
h 80.51"	STN321	515	670	940		810
h 89.17"	STN331	550	710	1.005		855
h 103.15"	STN341	595	775	1.085		930
Double unit						
w 72.36" x d 18.90"						
h 29.53"	STN102	685	850	1.210		1.030
h 37.40"	STN202	705	915	1.275		1.100
h 46.06"	STN302	770	1.015	1.420		1.230
h 60.04"	STN402	885	1.125	1.585		1.360
h 71.85"	STN222	965	1.260	1.765		1.510
h 80.51"	STN322	1.030	1.340	1.875		1.620
h 89.17"	STN332	1.095	1.420	2.005		1.710
h 103.15"	STN342	1.190	1.550	2.170		1.860
Row of 3 units						
w 108.07" x d 18.90"						
h 29.53"	STN103	1.030	1.275	1.810		1.545
h 37.40"	STN203	1.055	1.370	1.910		1.650
h 46.06"	STN303	1.150	1.520	2.130		1.845
h 60.04"	STN403	1.325	1.690	2.375		2.040
h 71.85"	STN223	1.445	1.885	2.645		2.265
h 80.51"	STN323	1.545	2.005	2.815		2.430
h 89.17"	STN333	1.640	2.130	3.010		2.565
h 103.15"	STN343	1.785	2.325	3.255		2.790
Row of 4 units						
w 143.82" x d 18.90"						
h 29.53"	STN104	1.370	1.700	2.415		2.060
h 37.40"	STN204	1.405	1.830	2.545		2.200
h 46.06"	STN304	1.535	2.025	2.840		2.460
h 60.04"	STN404	1.765	2.250	3.165		2.720
h 71.85"	STN224	1.925	2.515	3.525		3.020
h 80.51"	STN324	2.055	2.675	3.750		3.240
h 89.17"	STN334	2.185	2.840	4.010		3.420
h 103.15"	STN344	2.380	3.100	4.340		3.720
Row of 5 units						
w 179.53" x d 18.90"						
h.750 mm	STN105	1.725	2.125	3.025		2.575
h.950 mm	STN205	1.775	2.300	3.200		2.750
h.1170 mm	STN305	1.925	2.550	3.550		3.075
h.1525 mm	STN405	2.225	2.825	3.975		3.400
h.1825 mm	STN225	2.425	3.150	4.425		3.775
h.2045 mm	STN325	2.575	3.350	4.700		4.050
h.2265 mm	STN335	2.750	3.550	5.025		4.275
h.2620 mm	STN345	2.975	3.875	5.425		4.650
Row of 6 units						
w.5467 x d.480 mm						
h.750 mm	STN106	2.070	2.550	3.630		3.090
h.950 mm	STN206	2.130	2.760	3.840		3.300
h.1170 mm	STN306	2.310	3.060	4.260		3.690
h.1525 mm	STN406	2.670	3.390	4.770		4.080
h.1825 mm	STN226	2.910	3.780	5.310		4.530
h.2045 mm	STN326	3.090	4.020	5.640		4.860
h.2265 mm	STN336	3.300	4.260	6.030		5.130
h.2620 mm	STN346	3.570	4.650	6.510		5.580

Modular Storage Units

6. Colors and materials

MELAMINE

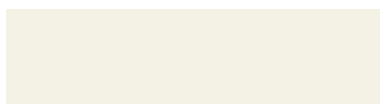

Lily white

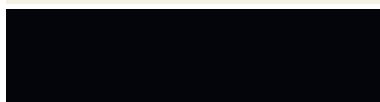

Black

FENIX HPL

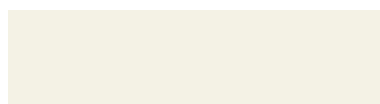

White 0029

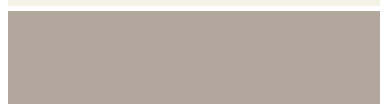

Beige Arizona 0748

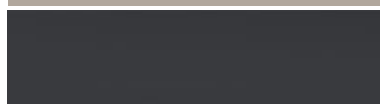

Grigio bromo 0724



Black 0720



Blu fes 0754



Verde comodoro 0750

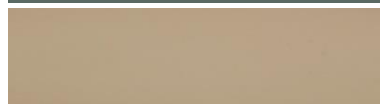

Beige luxor 0719



Rosso jaipur 0751

VENEER CATEGORY A



Ash



Walnut



Walnut mismatched



Cherry



European oak

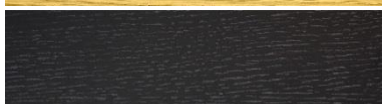

Black lacquered
European oak

VENEER CATEGORY B



Fossile oak



Fumed oak



Teak



Zebrano



Santos rosewood



Wenge

Mr. Walter

by BuloDesign



Mr. Walter

by BuloDesign

Mr. Walter is a tribute to the original file pedestal that Bulo began with in 1963. Made of wood, Mr. Walter is a contemporary storage collection that is both functional in the office environment as well as aesthetically warm in the home. Various accessories are available for organization and cushion tops can be added to create an extra seat for collaboration at the desk.

TECHNICAL INFORMATION

The carcass is made out of powdercoated mdf panels in mitre joint. The top panel is recessed offering a multifunctional use for office supplies, a cup of coffee, magazines or a cushion, allowing the pedestal to function as an additional seating element. The top panel can be finished in various melamine or veneer finishes to match with the colour and/or material of the table. The box file drawer can be used for hanging files, but also for binders or for personal items such as a handbag. The pedestal can be equipped with a central locking mechanism. The lock is black.





ENVIRONMENTALLY FRIENDLY

Compared to a metal pedestal, the Mr. Walter pedestal - carcass and fronts in wood - has a remarkably smaller ecological footprint. The production of powdercoated mdf ($\pm 60\%$ of the total material) absorbs more CO₂ than is emitted. The production of a Mr. Walter pedestal produces at least 50% less CO₂ emission than the production of a metal pedestal.

Mr. Walter

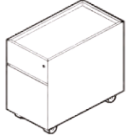
1. Pedestals

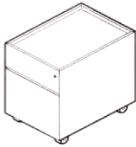
List prices

	Code	Top panel				
		melamine	Fenix hpl	veneer A	veneer B	
Small, w 12.76" x d 23.62" x h 20.94"/22.95"						
	1 drawer + 1 A4 filing drawer	WPESMT2 *	1.650	1.745	1.805	1.870
	3 drawers	WPESMT3 *	1.745	1.845	1.900	1.965
Medium, w 16.69" x d 23.62" x h 20.94"/22.95"						
	1 drawer + 1 A4 box file drawer	WPEMET2 *	1.705	1.835	1.900	1.975
	3 drawers	WPEMET3 *	1.770	1.910	1.965	2.040

* FINISHES & CODES

1) Carcass	3) Recessed top panel			4) lock
01 lily white	Melamine	Fenix hpl	Veneer A	K with cylinder lock
04 black	01 lily white	F1 white	ES ash	0 without lock
	04 black	F2 beige Arizona	NN walnut	
		F3 grigio bromo	NM walnut mismatched	5) Castors or glides
2) Drawer fronts		F4 black	KE cherry	C on castors, h.583 mm
01 lily white		F6 blue fes	EK oak	G on glides, h.532 mm
04 black		F7 verde comodoro	EE black lacquered oak	
		F8 beige luxor		
		F9 rosso jaipur		

Code example: WPEMET2010101KC = 1705

Mr. Walter

2. Credenzas

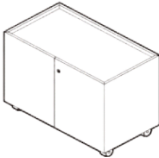
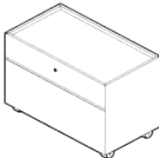
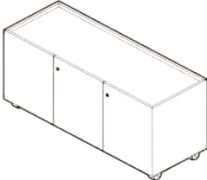
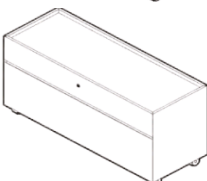
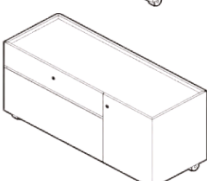
	Code	List prices				
		Top panel				
		melamine	Fenix hpl	veneer A	veneer B	
Medium, w 31.26" x d 17.24" x h 20.94"/22.95"						
	2 hinged doors incl. 1 shelf	WCRMET1 *	1.810	2.000	2.055	2.180
	1 drawer + 1 A4 box file drawer	WCRMET2 *	2.310	2.480	2.555	2.675
Large, w 47.01" x d 17.24" x h 20.94"/22.95"						
	1 double + 1 single right hinged door incl. 1 small and 1 large shelf	WCRLAT1 *	2.145	2.440	2.515	2.675
	1 drawer + 1 A4 box file drawer	WCRLAT2 *	2.660	2.930	3.025	3.190
	1 drawer + 1 A4 box file drawer + 1 right hinged door incl. 1 shelf	WCRLAT4 *	2.870	3.150	3.240	3.400

* FINISHES & CODES

1) Carcass	3) Recessed top panel				4) lock
01 lily white	Melamine	Fenix hpl	Veneer A	Veneer B	K with cylinder lock
04 black	01 lily white	F1 white	ES ash	ME fossile oak	0 without lock
	04 black	F2 beige Arizona	NN walnut	GE fumed oak	
		F3 grigio bromo	NM walnut mismatched	TE teak	5) Castors or glides
2) Drawer fronts		F4 black	KE cherry	ZE zebrano	C on castors, h.583 mm
01 lily white		F6 blue fes	EK oak	PL Santos Rose Wood	G on glides, h.532 mm
04 black		F7 verde comodoro	EE black lacquered oak	WE wenge	
		F8 beige luxor			
		F9 rosso jaipur			

Code example: WCRMET20404NNOG = 2.555

Mr. Walter

3. Accessories for pedestals and credenzas

List prices

Cushion for recessed top panel, for pedestal and credenza

	Code	Cat. 1	Cat. 2	Cat. 3	Cat. 4	Cat. 5
 small, w 11.42" x d 15.55"	WLTCUSM *	175	205	245	270	310
medium, w 15.55" x d 15.55"	WLTCUME *	175	205	245	270	310

Fittings

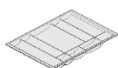

Pen-tray, w 13.46" x d 9.57" x h 0.98", black
(pedestals always include one pen-tray as a standard)

WLTPENTRAY

16



Filing tray
(max. 5 filing trays per drawer)

WLTPAPA04

18



Book support for box drawer small/medium, black
w 12.40"x d 6.30"x h 7.91"

WLTPABX04

54



Bottle holder and small box for box drawer medium, black

WLTPABO04

200



Holder with 3 bins

WLTPABIO4

205



Pen tray



Bottle holder



Holder with 3 bins

* FINISHES & CODES MR. WALTER CUSHIONS

Fabric cat. 1

QU... Quest

Fabric cat. 2

CE... César

CO... Comeback

MLF... Main Line Flax

RN... Renew

Fabric cat. 3

BL... Blazer

KEAT... Atom (Kent)

KECA... Castle (Kent)

KEHU... Hulk (Kent)

LALO... Lobo

ME... Meld

MR... Merit

RE... Remix 3

RW... Re-wool

Fabric cat. 4

AR... Arco

CA... Canvas 2

CL... Cleo

CR... Credo

EN... Encircle

SH... Shake

TP... Topia

Fabric cat. 5

HA... Hallingdal 65

CT... Steelcut 3

TR... Steelcut Trio 3

VI... Vidar 4

... = add fabric color code

Code example: WLTCUSMMLF02 = 205

Mr. Walter

4. Colors and materials

POWDERCOATED CARCASS AND FRONTS



Lily white

Black

MELAMINE



Lily white

Black

FENIX HPL



White 0029

Beige Arizona 0748

Grigio bromo 0724

Black 0720

Blu fes 0754

Verde comodoro 0750

Beige luxor 0719

Rosso jaipur 0751

VENEER CATEGORY A



Ash

Walnut

Walnut mismatched

Cherry

European oak

Black lacquered
European oak

VENEER CATEGORY B



Fossile oak

Fumed oak

Teak

Zebrano

Santos rosewood

Wenge

Digital or paper printing is not binding

Carte Blanche



Carte Blanche

Bulo's unique collaboration with architects and designers from outside the company - few of them are specialized in furniture or interior design - has resulted in uncompromising, smart designs
These talented people present their vision of their ideal workstation in Bulo's Carte Blanche collection.

Carte Blanche

1. Easy Rider

by Danny Venlet



Inspired by uninspiring seating in airport waiting areas, Danny Venlet created this mobile desk-seat. It's a unique piece that offers a variety of function including lounging, working on a laptop, or simply sitting. It works in a range of environments – from libraries, cafes to workplace collaboration. Capacity: 100 kg

Frame injected in EPP (expanded polypropylene), covered with 3D-knitted fabric
Diam. 47.24" x h 29.33"
Seat height: 17.13"

Code

List prices

1.1. On castors

black legs

CBDVWIZWST *

6 385

1.2. On glides

black legs

CBDVRDZWST *

6 385

* FINISHES & CODES

Colors and materials

Unicolored fabric

Code	Color	Seams
06	Bulo-red	black
07	rose	black
08	brown	black
09	blue	black
10	black	Bulo-red
12	grey	black

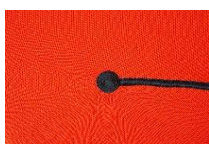

06
Bulo-red

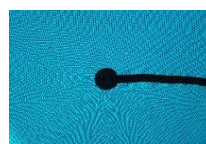

09
blue



07
rose



10
black

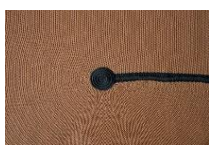

08
brown



12
grey

Code example: CBDVWIZWST06 = 6 385

Carte Blanche

2. Overdose





by Bram Boo



The Overdose is workspace inspired by the designer's own mess. It is Bram Boo's concept of making order through disorder. Its aesthetics of organized chaos brings movement and fun into a space.

Base: steel, powdercoated lily white
 Top: mdf 1.97" thick powdercoated lily white
 Boxes: multiply veneered with natural European oak

Storage and Organiser: multiply veneered with natural European oak

		Code	List prices
Desk			
	Overall dimensions: w 91.06" x d 51.30" x h 55.51" Work surface: w 62.28" x d 27.56" x h 29.53"	CBBBOD01EK	16 565
Organiser	w 27.95" x d 27.17" x h 11.02"	CBBBOOEK	5 960
			
Small storage	w 33.50" x d 46.57" x h 40.94" 5 boxes	CBBBKKEK	19 335
			
Large storage	w 75.20" x d 48.23" x h 76.77" 7 boxes	CBBBOKEK	37 345
			

Colors and materials

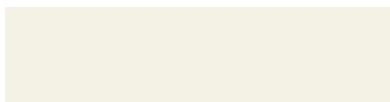

lily white
 powdercoated



European oak
 veneer, natural

Montado Cork Objects

by Studio Corkinho & BuloDesign



Montado Cork Objects

by Studio Corkinho & BuloDesign

The Mondado collection is developed to help organize your work environment in an enjoyable way. Both home offices and the homey office spaces will benefit from the tactile warmth, acoustic qualities and calming scents originating from the objects. The collection covers a set of organizers; flexible division screens and an online meeting assistant.

This collection was developed in collaboration with Studio Corkinho. Studio Corkinho is a multi-disciplinary design studio from Antwerp, aiming to change people's perceptions and awareness of objects and materials that we think deserve attention because of their unique values.

The name Montado refers to the region in which cork oaks grow and are being harvested.

TECHNICAL DESCRIPTION

Cork is the bark of the cork oak (*Quercus Suber L.*), which means that it is a 100% natural plant tissue. The bark is harvested every nine years while the tree remains unharmed.

As a 100% natural, sustainable and highly technological material, cork gains new forms and functionalities to meet the most demanding requirements. Cork is used to create new new solutions that, through combination with different materials, guarantee the best possible performance of the final products.

The cork can be used in its natural form, burned or in combination with recycled rubber granulates and is pressed together into a block using a polyurethane binder.

Cork is 100% recyclable and the materials are tested for fire resistancy according to EN ISO 9239-1 - classification CFL - s1

Montado Cork Objects

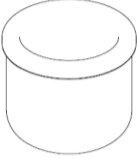
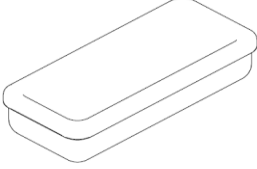
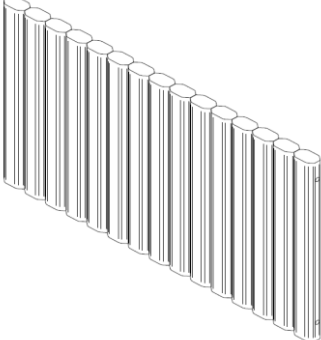
	Material	Code	List prices
1. Pen holder Outer dim.: diam. 3.54" x h 3.54"			
	Natural fine grain cork	COROR18003	100
	Confetti cork	COROR15923	100
	Burnt cork	COROR18703	100
2. Pen tray Outer dim.: w 7.87" x d 3.54" x h 1.57"			
	Natural fine grain cork	COROR28003	95
	Confetti cork	COROR25923	95
	Burnt cork	COROR28703	95
3. Flexible dividing screen Dim.: w 32.28" x d 1.38" x h 17.72"			
	Cork mélanger	CORWND9001	860
	Confetti cork	CORWND5923	860
	Burnt cork	CORWND8703	860

Montado Cork Objects

Colors and materials

CORK



natural fine
grain



mélanger



confetti

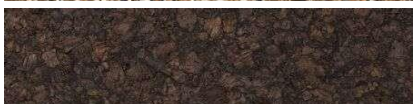

burnt

Fabrics



FABRICS



	DAN Lounge	Monica	P&C	SL58	SLL18	TAB Chair	TAB Lounge	VVD Chair	VVD Slim Chair	VVD Bistro Chair	Screens
CATEGORY 1											
Carlow by Camira Fabrics											✓
Quest by Camira Fabrics		✓		✓	✓	✓	✓			✓	✓
CATEGORY 2											
César (Aquaclean) by Aristide	✓	✓		✓	✓	✓	✓	✓	✓	✓	
Comeback by Keymer	✓	✓		✓	✓	✓	✓	✓	✓	✓	
Corduroy by Bulo (until end of stock)			✓								
Extrema AU (+) by Flukso		✓		✓	✓	✓	✓			✓	
Main Line Flax by Camira Fabrics	✓	✓	✓	✓	✓	✓	✓	✓	✓	✓	✓
Renew by Keymer	✓	✓		✓	✓	✓	✓			✓	
CATEGORY 3											
Blazer by Camira Fabrics	✓	✓	✓	✓	✓	✓	✓	✓		✓	✓
Kent/Atom-Castle-Hulk (Crypton) by Aristide		✓		✓	✓	✓	✓			✓	
Lobo (Crypton) by Aristide	✓	✓		✓	✓	✓	✓			✓	✓
Meld by Maharam	 ✓	✓		✓	✓	✓	✓	✓	✓	✓	✓
Merit by Maharam	 ✓	✓	✓	✓	✓	✓	✓	✓	✓	✓	✓
Remix 3 by Kvadrat				✓	✓	✓		✓		✓	✓
Re-Wool by Kvadrat	 ✓	✓	✓	✓	✓	✓	✓			✓	✓

FABRICS



	DAN Lounge	Monica	P&C	SL58	SLL18	TAB Chair	TAB Lounge	VVD Chair	VVD Slim Chair	VVD Bistro Chair	Screens
CATEGORY 4											
Arco by Rohi	✓	✓	✓	✓	✓	✓	✓	✓	✓	✓	✓
Canvas 2 by Kvadrat				✓	✓	✓	✓	✓		✓	✓
Cleo by Rohi	✓	✓	✓	✓	✓	✓	✓	✓	✓	✓	✓
Credo by Rohi	✓	✓	✓	✓	✓	✓	✓	✓	✓	✓	✓
Encircle by Kvadrat	✓	✓		✓	✓	✓	✓			✓	
Shake by Rohi	✓	✓	✓	✓	✓	✓	✓		✓	✓	✓
Topia by Rohi	✓	✓	✓	✓	✓	✓	✓	✓	✓	✓	✓
CATEGORY 5											
Hallingdal 65 by Kvadrat	✓	✓	✓	✓	✓	✓	✓	✓	✓	✓	✓
Steelcut 3 by Kvadrat	✓	✓	✓	✓	✓	✓	✓	✓	✓	✓	✓
Steelcut Trio 3 by Kvadrat	✓	✓	✓	✓	✓	✓	✓	✓	✓	✓	✓
Vidar 4 by Kvadrat	✓	✓	✓	✓	✓	✓	✓	✓	✓	✓	✓
CATEGORY 6											
Judith, color crème by Pierre Frey	✓	✓		✓	✓	✓	✓			✓	
CATEGORY 7											
Louison, color crème by Pierre Frey	✓	✓		✓	✓	✓	✓			✓	
LEATHER	✓	✓	✓	✓	✓	✓	✓	✓	✓	✓	

(+) = 4 colors available: 2250 black, 4550 light blue, 1550 petrol and 4450 mushroom
 Fabric suited for outdoor use, but it does not make the product suited for outdoor use.
 Within the Bulo collections there is no furniture suited for outdoor use.

Tab Mesh chairs are only available in the standard fabric, other upholstery or COM/COL are not possible

Upholstery Fabrics

Carlow

Category 1 | CLW

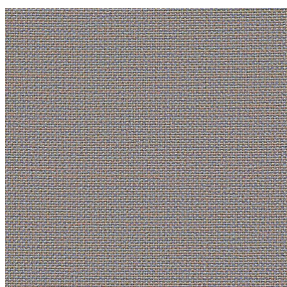

Textile mill Camira

Composition 100% Polypropylene

Weight 214 g/m2 ±5%

Light resistance 6 (ISO 105 - B02)

Flammability EN 1021-1 (cigarette), EN 13501-1 Adhered Class B, s1, d0, EN 13501-1 Un-adhered Class C, s1, d0

All colorways available

Quest

Category 1 | QU

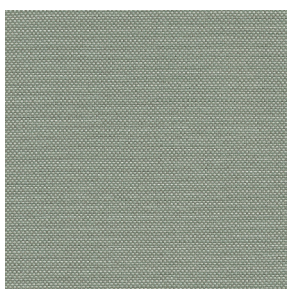

Textile mill Camira

Composition 100% post-consumer recycled polyester including 75% SEAQUAL® YARN

Weight 330g/m2 ±5%

Abrasion Heavy duty / 10 year guarantee. Independently certified to ≥100,000 Martindale cycles

Light resistance 4-6 (ISO 105 - B02)

Flammability EN 1021 - 1 (cigarette), EN 1021 - 2 (match), BS 7176 Low Hazard UNI 9175 Classe 1 IM, BS 476 Part 7 Class 1Y (Adhered), EN 13501-1 Adhered Class B, s1, d0, EN 13501-1 Un-adhered Class B, s1, d0, BS 5852 Ignition Source 5 with EnviroFlam5, BS 7176 Medium Hazard with EnviroFlam5, IMO FTP Code (Part 8) with EnviroFlam5

All colorways available

Upholstery Fabrics

César

Category 2 | CE

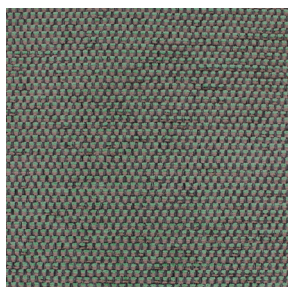

All colorways available

Textile mill Aristide

Composition 100% PES

Weight 565 gr/rm

Abrasion Martindale 60,000 rubs (BS 5690)

Light resistance 4

Flammability BS5852, ignition source 0 & 1 (cigarette & match), EN1021, EN1021-1 (cigarette) & EN1021-2 (match)

Aquaclean Aquaclean treatment system covers every single fiber with an invisible molecular coating. This avoids dirt to penetrate the fibers, which helps to maintain the fabric and prolong the life of your sofa cover. Use just water to clean occasional stains like wine, coffee and food.

Comeback

Category 2 | CO

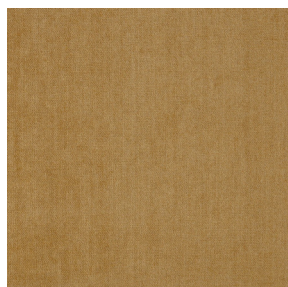

All colorways available

Textile Mill Keymer

Composition 86% PL, 9% CO, 5% MA

Abrasion 200.000 Martindale

Fastness to light 6

Flammability EN1021 1 & 2

Corduroy

Category 2 | CO

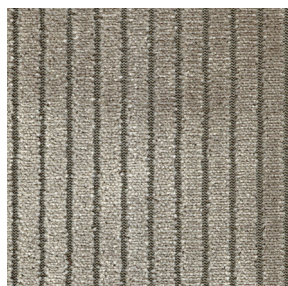

All colorways available

By Bulo

Composition: Pile: 65% polyester – 35% cotton

Weft: 63% protex – 25% polyester – 17% viscose

Warp: 65% polyester – 35% viscose

Weight: 695 gr/ m

Martindale test: + 40000 turns

Colourfastness: 6 ISO 105 / B02 method 1 (1994)

Fire standard: BS5852 part 1 & 2 cigarette test + butane flame test

Upholstery Fabrics

Extrema AU

Category 2 | EX

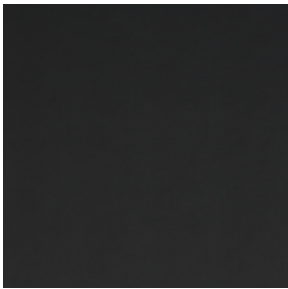

Textile mill Flukso

Composition: 63% Polyurethane - 29% COT 8% Polyester

Weight: 480 g/m2

Abrasion: 150.000 Martindale rubs, ISO 12947-2

Fastness to light: 5/6, IISO 105-B02

Flammability UNI 9175 classe 1 IM, EN 1021 part. 1-2, BS 5852 crib 5, BS 5852

Source 1, IMO 2010 FTP CODE | TB 117: 2013



Mainline Flax

Category 2 | MLF

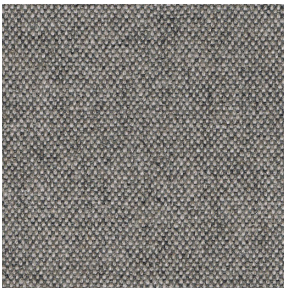

Textile mill Camira fabrics

Composition 70% Pure New Wool, 30% Flax

Weight 13 oz/sq yd

Abrasion ≥100,000 double rubs, ASTM D4157 Wyzenbeek method

Fastness to light 4, AATCC-16 (40 hours)

Flammability California Technical Bulletin 117 - 2013, NFPA 260 + UFAC Class 1, BS 7176 Low Hazard, ASTM E84 Class 1 or A (Adhered)

All colorways available

Renew

Category 2 | RN

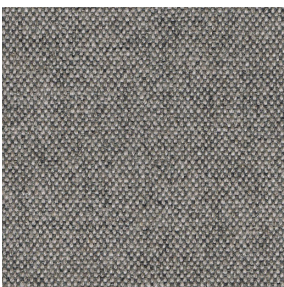

Textile mill Keymer

Composition 76% pp, 10% pl, 8% ma, 6% co

Rubbing 35.000 Martindale

Light fastness 6

Flammability FR EN 1021 1&2,

Environmental Consists of 70% biodegradable polyolefin and is partially made from recycled yarn.

All colorways available

Upholstery Fabrics

Blazer

Category 3 | BL

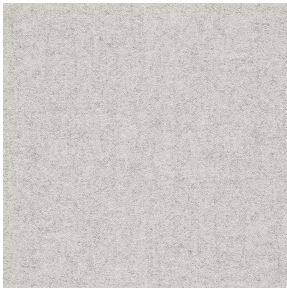

Textile mill Camira fabrics

Composition 100% Pure New Wool

Weight 13 1/2 oz/sq yd

Abrasion ≥75,000 double rubs, ASTM D4157 Wyzenbeek method

Fastness to light 4, AATCC-16 (40 hours)

Flammability California Technical Bulletin 117 - 2013, NFPA 260 + UFAC Class 1, BS 7176 Low Hazard, ASTM E84 Class 1 or A (Adhered)

All colorways available

Kent

Category 3 | KE



Weight 578 g/rm

Abrasion 100 000

Textile Mill Aristide

Composition 100%PES

Pilling 4-5

Fastness to light 6

Flammability BS5852, ignition source 0 & 1 (cigarette & match), EN1021, EN1021-1 (cigarette) & EN1021-2 (match)

Atom



Weight 520 g/rm

Abrasion 100 000

Castle



Weight 453 g/rm

Abrasion 40 000

Aquaclean Stain resistant. Odor resistant. Moisture resistant. Repels oil and water based spills. Integrated liquid-resistant barrier. Anti-bacterial and fungal growth resistance. Protection sealed in every fibre. Easy to clean. Greenguard Gold Certified.

Hulk

Lobo

Category 3 | LALO

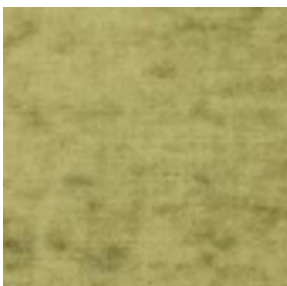

Textile mill Aristide

Composition 100%PES (velvet)

Weight 406 g/rm

Abrasion 50.000 rubs

Pilling 5

Fastness to light 6/7

Flammability BS5852, ignition source 0 & 1 (cigarette & match), EN1021, EN1021-1 (cigarette) & EN1021-2 (match) **Crypton** technology stain and odor resistant, integrated non-porous moisture barrier, protection against bacteria and odor causing microbes, using silver ion technology, disinfectable, permanent and patented protection engineered on a molecular level, Greenguard Gold certified.

Upholstery Fabrics

Meld

Category 3 | ME

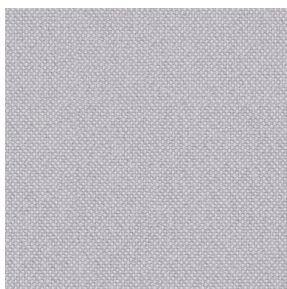

All colorways available

Textile mill Maharam

Composition 68% Post-Consumer Recycled Polyester, 32% Polyester

Finish Stain repellent

Weight 500 g/lm

Abrasion ASTM D4157, 100,000 double rubs Wyzenbeek

Fastness to light AATCC 16E, 40+ hours

Flammability AS/NZS 1530.3, AS/NZS 3837 Unadhered, ASTM E 84 Unadhered, CAL 117-2013, CAN ULC S102 Unadhered

Environmental Greenguard Gold Certified, Greenguard Certified, GRS Certified Content, REACH Compliant, Contains Recycled Content, FR Free

Merit

Category 3 | MR

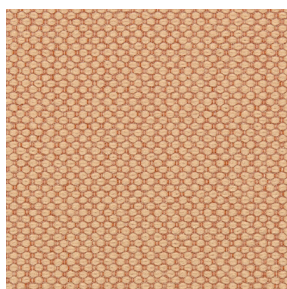

All colorways available

Textile mill Maharam

Composition 76% Post-Consumer Recycled Polyester, 24% Polyester

Weight 17.1 oz/ly (500 gr/lm)

Abrasion ASTM D4157, 100,000 double rubs Wyzenbeek

Fastness to light AATCC 16E, 40+ hours

Flammability AS/NZS 1530.3, AS/NZS 3837 Unadhered, ASTM E 84 Unadhered

BS 476 Unadhered*, BS 5852 Crib 5*, CAL 117-2013, CAN ULC S102 Unadhered
EN 1021-1*, EN 1021-2*, EN 13501 Unadhered*, GB/T 17591*, ISO 5660 Unadhered
NFPA 260, SN 198 898*, *passes with additional treatment

Environmental, Greenguard Gold Certified, GRS Certified Content, REACH Compliant, Contains Recycled Content, FR Free

Upholstery Fabrics

Remix 3

Category 3 | RE



All colorways available

Textile mill Kvadrat

Composition 90% new wool worsted 10% nylon

Weight 420 g/lm

Abrasion 100.000 Martindale

Pilling 4

Fastness to light 6

Flammability AS/NZS 1530.3, BS 5852 part 1, IMO FTP Code 2010 Part 8, NF D 60 013, NFPA 260, UNI 9175 1IM, US Cal. Bull. 117-2013, EN 1021-1/2, AS/NZS 3837 class 2, ÖNORM B1/Q1, ASTM E84 Class A Unadhered, ASTM E84 Class A Adhered

Re-wool

Category 3 | RW

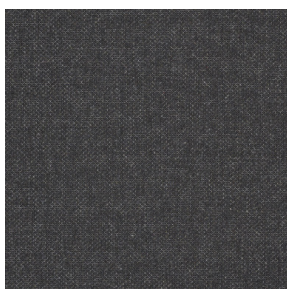

All colorways available

Textile mill Kvadrat

Composition 5% New wool (worsted), 45% Recycled wool, 10% Nylon

Weight 540 g/lin.m

Sustainability Complies with EU ecolabel "The Flower"

Abrasion 100.000 Martindale

Pilling 4

Fastness to light 7

Flammability BS 5852 Crib 5 with treatment, BS 5852 ignition source 3, BS 5852 part 1, EN 1021-1/2, NF D 60 013, UNI 9175 1IM, US Cal. Bull. 117-2013, ÖNORM B1/ Q1, AS/ NZS 3837 Class 2

Arco

Category 4 | AR

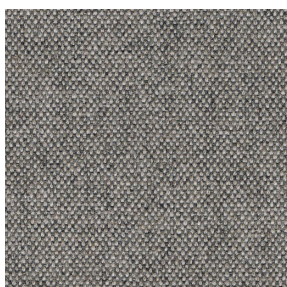

All colorways available

Textile mill Rohi

Composition 95% virgin wool 5% polyamide

Weight 700 g/m2 - 980 g/lm

Abrasion 70.000 rubs ISO 12947-2

Fastness to light ≥ 5 ISO 105-B02 (yarn dyed)

Flammability wool is naturally flame retardant. Rohi wool fabrics satisfy the following standards with no additional flame retardant finish: CAL TB 117 - 2013, DIN EN 1021-1/ -2, BS 5852 part 1: 1979, UNI 9175 1 IM, IMO 2014/90/EU, Marine Equipment Directive (MED)

Upholstery Fabrics

Canvas 2

Category 4 | CA



All colorways available

Textile mill Kvadrat

Composition 90% New wool (worsted), 10% Nylon

Weight 480 g/lin.m

Abrasion 100.000 Martindale

Pilling 4

Fastness to light 6

Flammability AS/NZS 1530.3, BS 5852 part 1, EN 1021-1/2, IMO FTP Code 2010 Part 8, NF D 60 013, NFPA 260, SN 198 898 5.3 with treatment, UNI 9175 1IM, US Cal. Bull. 117-2013, ÖNORM B1/ Q1, BS 5852 ignition source 3, BS 5852 Crib 5 with treatment

Cleo

Category 4 | CL

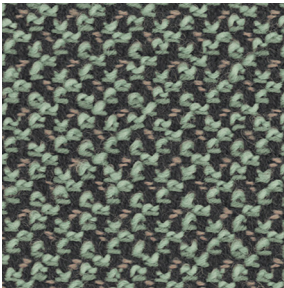

All colorways available

Textile mill Rohi

Composition 95% virgin wool 5% polyamide

Weight 690 g/m² - 970 g/lm

Sustainability natural, renewable material, IWTO Guidelines for Wool Sheep Welfare, RAL DE-UZ 117 Att. 3b for "Blue Angel", without flame retardant AB 2998 (US export standard), REACH (EU export standard)

Abrasion 70.000 rubs ISO 12947-2

Pilling ≥ 4-5 ISO 12945-2

Fastness to light ≥ 5 ISO 105-B02 (yarn dyed)

Flammability wool is naturally flame retardant, rohi wool fabrics satisfy the following standards, with no additional flame retardant finish:, CAL TB 117 – 2013, DIN EN 1021-1/ -2, BS 5852 part 1: 1979, UNI 9175 1 IM, ÖNORM B1/Q1, IMO 2014/90/EU Marine Equipment Directive (MED)NZS 3837 Class 2. With additional flame retardant finish: BS 5852: 2006 Crib5, DIN 4102-1 B2, DIN EN 13501-1 E, FAR 25.853 12 sec. vertical, BKZ 5.3 SN 198898

Credo

Category 4 | CR

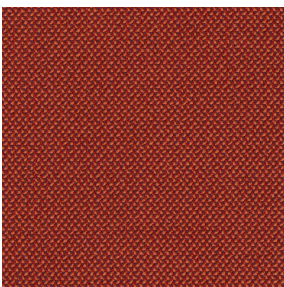

Textile mill Rohi

Composition 95% New Wool, 5% PA (polyamide)

Weight 610 g/m² - 870 g/lfm

Abrasion 100.000 rubs, ISO 12947-2

Pilling ≥ 4-5, ISO 12945-2

Fastness to light ≥ 5, ISO 105-B02

Flammability FAR 25.853 (12 sec. vertical), CAL TB 117 - 2013, DIN 4102-1 B2, DIN EN 13501-1, DIN EN 1021 -1 und -2, BS 5852:1979 (part1), BS 5852:2006 (part2) Crib5, BKZ: 5.3 SN 198898, UNI 9175 (1 IM), NF P92 503-507 M2, IMO: 2014/90/EU Marine Equipment Directive

Upholstery Fabrics

Encircle

Category 4 | EN

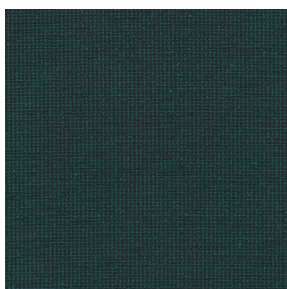

Textile mill kvadrat

Composition 100% Trevira CS

Weight 560 g/m² (18.06 oz/sq ft)

Sustainability Greenguard Gold, HPD, EPD

Abrasion 80,000 Martindale

Pilling 4 (ISO 1-5)

Fastness to light 6

Flammability BS 5852 Crib 5 • AS/NZS 3837 class 1 • DIN 4102 B1 • IMO FTP Code 2010 Part 8 • NF P 92 507 M1 • NFPA 701 • ÖNORM B1/Q1 • NF D 60 013 • SN 198 898 5.2 • EN 1021-1/2 • UNI 9175 1IM • US Cal. Bull. 117-2013 • ASTM E84 Class A Unadhered • BS 5867 part 2 type B • EN 13501-1, B-s1, d0 • CAN ULC S102 • CAN ULC S109

Shake

Category 4 | SH

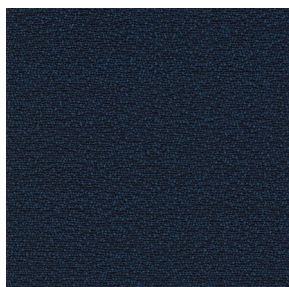

Textile mill Rohi

Composition 95% WV 5% PA

Weight 440 g/m² - 660 g/lm

Abrasion ≥ 70.000 rubs ISO 12947-2

Pilling ≥ 4-5 , ISO 12945-2

Fastness to light ≥ 5, ISO 105-B02 (yarn dyed)

Flammability CAL TB 117 - 2013, DIN EN 1021 -1 / -2, BS 5852:1979 (part1), UNI 9175 (1 IM), ÖNORM B1/Q1, IMO 2014/90/EU Marine Equipment Directive.

All colorways available

Upholstery Fabrics

Topia

Category 4 | TP

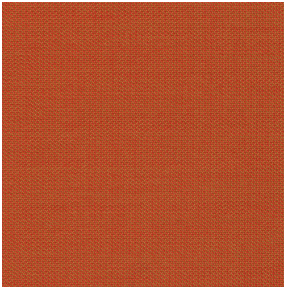

All colorways available

Textile mill Rohi

Composition 95% Wool, 5% PA

Weight 440 g/m² - 660 g/lfm

Abrasion 50.000 rubs, ISO 12947-2

Pilling ≥ 4-5, ISO 12945-2

Fastness to light ≥ 5, ISO 105-B02

Flammability FAR 25.853 (12 Sek. vertikal), CAL TB 117 - 2013, DIN 4102-1 B2, DIN EN 13501-1, DIN EN 1021 -1 and -2, BS 5852:1979 (part1), BS 5852:2006 (part2) Crib5, BKZ: 5.3 SN 198898, UNI 9175 (1 IM), IMO: 2014/90/EU Marine Equipment Directive, Train: EN 45545-2 R21 ISO 5660-1 (HL3)

Hallingdal 65

Category 5 | HA

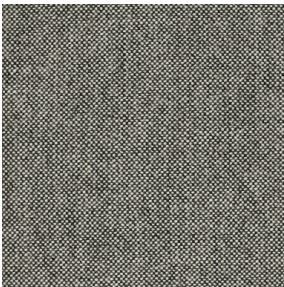

All colorways available

Textile mill Kvadrat

Composition 70% New wool, 30% Viscose

Weight 795 g/lin.m

Sustainability Complies with EU ecolabel "The Flower"

Abrasion 100.000 Martindale

Pilling 3-4

Fastness to light 7

Flammability AS/NZS 1530.3, BS 5852 Crib 5, BS 5852 part 1, EN 1021-1/2, IMO FTP Code 2010 Part 8, NF D 60 013, NFPA 260, SN 198 898 5.3 with treatment, UNI 9175 1IM, US Cal. Bull. 117-2013, ÖNORM B1/ Q1, BS 5852 ignition source 3

Steelcut 3

Category 5 | CT

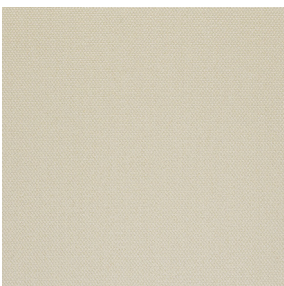

All colorways available

Textile mill Kvadrat

Composition 90% New wool (worsted), 10% Nylon

Weight 825 g/lin.m

Sustainability Complies with EU ecolabel "The Flower"

Abrasion 100.000 Martindale

Pilling 3-4

Fastness to light 6

Flammability AS/NZS 3837, class 2, BS 5852 part 1, EN 1021-1/2, IMO FTP Code 2010 Part 8, NF D 60 013, SN 198 898 5.3 with treatment, UNI 9175 1IM, US Cal. Bull. 117-2013, ÖNORM B1/ Q1, BS 5852 Crib 5 with treatment, NFPA 260, AS/NZS 1530.3

Upholstery Fabrics

Steelcut Trio 3

Category 5 | TR

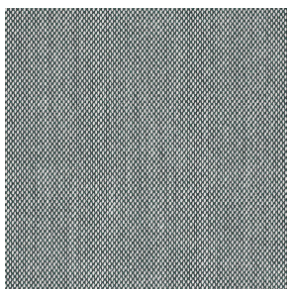

All colorways available

Textile mill Kvadrat

Composition 90% New wool (worsted), 10% Nylon

Weight 770 g/lin.m

Sustainability Complies with EU ecolabel "The Flower"

Abrasion 100.000 Martindale

Pilling 4

Fastness to light 5

Flammability AS/NZS 3837, class 2, BS 5852 part 1, EN 1021-1/2, IMO FTP Code 2010 Part 8, NF D 60 013, NFPA 260, SN 198 898 5.3 with treatment, UNI 9175 1IM, US Cal. Bull. 117-2013, ÖNORM B1/ Q1, BS 5852 Crib 5 with treatment, AS/NZS 1530.3, BS 5852 ignition source 3

Vidar 4

Category 5 | VI

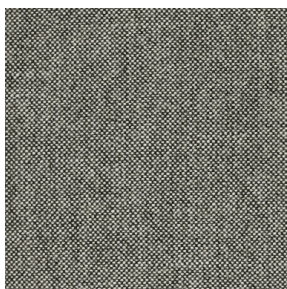

All colorways available

Textile mill Kvadrat

Composition 94% new wool 6% nylon

Weight 770 g/m² (24.84 oz/sq ft)

Sustainability Complies with EU ecolabel "The Flower"

Abrasion 100,000 Martindale

Pilling 4 (ISO 1-5)

Fastness to light 7

Flammability BS 5852 crib 5 with treatment • BS 5852 part 1 • IMO FTP Code 2010 Part 8 • NF D 60 013 • NFPA 260 • UNI 9175 1IM • US Cal. Bull. 117-2013 • EN 1021-1/2 • AS/NZS 3837 class 2 • GB 50222 B1 with treatment (Chinese) • SN 198 898 5.3 with treatment • IMO FTP Code 2010 Part 7 with treatment • NFPA 701 with treatment

Judith

Category 6 | JUDCR



Textile mill Pierre Frey

Composition 79% Wool - 21% Cotton

Bouclé/loop pile fabric

Weight 1181 g/lm

Abrasion > 50.000 Martindale

Flammability BS5852 Cigarette & Match test - BS5852 Cigarette test - CRIB 5, in conjunction with suitable combustion modified foam - NFPA 260 - Class 1 - EN1021-1-20

Upholstery Fabrics

Louison

Category 7 | LOUCR



Textile mill Pierre Frey

Composition 41% Wool - 39% Alpaca - 17% Cotton - 3% Acrylic

Weight 1349 g / ml

Bouclé/loop pile fabric

Abrasion > 50.000 Martindale

Flammability BS5852 Cigarette & Match test - BS5852 Cigarette test - CRIB 5, in conjunction with suitable combustion modified foam - NFPA 260 - Class 1 - EN1021-1-20

General Conditions

This price list is valid as from 1st January 2025. It supersedes and replaces all previous price lists. Prices exclude taxes and shipment. Images and descriptions in all catalogues and price lists are for reference only. Variations in structure and color may occur.

Bulo may change prices and/or change specifications of products and/or take products out of collection at any time.

Codes and prices are indicated in bold in this price list as a way of showing an example how to form codes and calculate prices.

Orders are accepted definitively as soon as they are confirmed in writing. Cancellations by the client are not accepted, barring certain exceptions agreed by Bulo within 5 working days. An unpaid deposit invoice does not entitle the buyer to cancel (part of) the order.

Bulo is not responsible if delivered goods do not comply with whichever legal, technical and coordinative aspect laid down by the country or region in which the products have been installed. Whether or not goods comply with whichever local regulation is the sole responsibility of the buyer.

UPHOLSTERY

Bulo carefully selected their standard materials and fabrics. If the customer wants to use materials outside of the standard collection, Bulo reserves the right to test COM or COL before accepting the order, and if not suited as upholstery to refuse the order. In case a sample chair or sofa needs to be produced to test the suitability of the COM or COL, this will be done in consultation with and after agreement of the client prior to production. The sample chair or sofa will be charged to the client. All freight costs and customs related duty & clearance fees are the responsibility of the customer when sending COM/COL to Bulo. With the use of COM or COL, even if Bulo accepted the order, there is no guarantee on the fabric or leather, its behavior on the chair or sofa after either short or long term use, nor on pilling or creasing. Our standard guarantee applies to the upholstered parts of the product only. Bulo can not be held responsible for the fact that light colors tend to get dirty rather quickly. Leather is a precious and valuable product. No two are alike. A variety of markings like healed scars and abrasions may be visible and are not considered defects but rather add to the character of the piece, reflecting its history. All leather will stretch and form comfort creases as a result of being sat on. The effect is called puddling. Puddling occurs from the initial use period and generally does not continue beyond this, as the amount of stretch is directly related to the amount of compression. Puddling is not a fault with the leather; rather it is a good indication of quality manufacturing as large pieces of leather are used. The creases do not diminish the quality of leather upholstered furniture. It is a natural process. Climate affects fabric just as it does wood. Heat, cold, humidity and sunlight contribute to fabric instability. Jewelry, silverware, even a sharp pencil can mark the upholstery. It's important to keep sharp objects away from your furniture. External dyeing caused by products with insufficient color fastness such as jeans, cannot be avoided

WOOD IS A NATURAL MATERIAL

We point out that wood is a natural material.

In products where veneer or solid wood is applied it is therefore possible that there is variation in color and grain within one order with multiple products in the same veneer or solid wood, or even within one product.

Our veneer samples are made from another tree than the veneer for the final product. This means that the veneer for the final product can deviate in color and design from our veneer samples.

Under the influence of light a discoloration of the original (or natural) wood colour occurs (ask Bulo or your Bulo partner for explanation and advice). Extremely important for the condition of the wood is maintaining the relative humidity as constant as possible (approx. 60%) to avoid drying, and with it shrinking of the wood.

GUARANTEE

Bulo products are under guarantee for a 10 year period for manufacturing defaults following the date of delivery.

Each Bulo product has been manufactured with exceptionally high quality materials and with the greatest possible care. The product leaves the factory only after a thorough quality control. Should in spite of our control a material- or production fault occur, Bulo will exchange or repair the product or provide the necessary replacement parts, corresponding to the delivery conditions valid at the time the delivery of the product occurred.

This guarantee is valid on the sole condition that the care and maintenance instructions were correctly applied and the product was used in regular fashion. Defaults that occur due to injudicious use are exempt from the guarantee.

Appealing to the Bulo guarantee for manufacturing defaults is possible within the guarantee period that starts from the date of delivery to the first owner or at the latest from 30 days after delivery of the goods to the Bulo dealer.

Application on the guarantee can be directed either to Bulo or to your Bulo dealer, only on presentation of the invoice. Bulo or your Bulo dealer will take care of the complaint.

Specific exclusions :

- Excessive wear and tear is not covered by the guarantee.
- Damages occurred through improper use or incorrect maintenance are exempt from the guarantee.
- Indirect damages following a possible defect, such as loss of income, etc... are not covered by the guarantee.
- Repairs on the product or upholstery executed without written consent from Bulo are exempt from the guarantee.
- The guarantee does not apply on leather and fabric upholstery, gaslifts and castors, for which a 1 year guarantee applies.
- Materials that are not part of the standard Bulo collections, used on explicit instructions of the buyer, are not covered by the guarantee, amongst them COM and COL.

- Damage caused during onwards transport or improper storage of the product or damage caused by accident are exempt from the guarantee.
 - Color variations. While every effort is made to ensure parity of color, Bulo can't guarantee an exact color match in any painted or wood finish or guarantee against commercial variance in fabrics, especially on repeat orders.
 - Natural product changes, due to aging, exposure to light and naturally occurring markings, scarring and wrinkles in leather. These are not covered by the guarantee.
 - Damage to a chair or sofa due to impact caused by the user is not covered by the guarantee.
 - Damage to property or injury caused through the use of Bulo products are not covered by the guarantee.
 - The use of an outdoor fabric does not make the chair/sofa suitable for outdoor use. Within the Bulo collections there is no furniture suited for outdoor use. Bulo furniture used outdoors is not covered by the guarantee.
 - Damage to black powdercoated horizontal surfaces or black melamine horizontal surfaces.
- For products or parts that Bulo procures with third parties Bulo applies the same guarantee as the guarantee conditions that Bulo receives from the supplier, with a minimum of 12 months.

DAMAGED GOODS

Bulo guarantees that products are in impeccable condition when leaving the warehouse in Mechelen, Belgium.

Bulo guarantees an export-worthy packaging for normal transport conditions for road, sea and air freight by external forwarders. It is imperative that the condition of the packaging at receipt of the goods is photographed by the receiver and can be passed on to Bulo in case of damage to goods. Without photographs of the packaging prior to moving or unpacking, a claim about damaged goods will not be accepted.

Photographs of damaged goods taken after trans-shipment, after changing our packaging or after installation only will not be accepted in a claim, unless they are accompanied by visible proof that the damage occurred prior to the trans-shipment/changing our packaging/installation.

Visible transport damage or loss MUST be noted on the carrier's CMR consignment note. This must be reported to the carrier and to Bulo in writing within 24 hours following the delivery, accompanied by photographs taken at the moment of delivery as described above and a copy of the CMR consignment note.

In case of visible transport damage, the goods need to be inspected immediately to determine whether there is damage to the goods. Damage to goods inside visibly damaged packaging needs to be reported to Bulo within 48 hours after receipt of the goods, accompanied by at least 1 detailed photograph of each damage, at least 1 photograph of the entire product and the photographs taken at the moment of delivery as described above.

Damage to goods inside undamaged packaging needs to be reported to Bulo within 7 calendar days after receipt of the goods, accompanied by a photograph of taking the damaged part out of the packaging, at least 1 detailed photograph of each damage, 1 photograph of the entire product and photographs taken at the moment of delivery as described above.

RETURN OF GOODS

Returned goods are not accepted unless the sender has received written consent and despatch instructions from Bulo.

DELIVERY CONDITIONS OUTSIDE BELGIUM

The prices in the price list are ex-works.

Bulo can organize the shipment for you. Please contact us for additional information and/or a shipment quotation.

For delivery by Bulo to a warehouse, the client will provide a warehouse address that complies with the following conditions: easy access route and ample parking space for a truck with a 44' long trailer. The truck will be without tailgate lift unless otherwise agreed by Bulo beforehand. A forklift truck has to be on site, as well as personnel to offload and take the goods inside. Installation and waste disposal not included. Delivery during regular working hours only.

Delivery to an address without warehouse facilities, always in consultation with Bulo, subject to an upcharge.

Delivery dock-to-dock.

Installation at site by the buyer.

When delivery ex-works, the liability for the goods is transferred from Bulo to the buyer from the moment the goods have left Bulo's warehouse. We advise ex-works customers to insure products during transport.

PCON/Revit

In case of a price difference between pCon and this price list, it's the price in this price list that is valid and that will be charged.

In case of a finish anomaly between pCon/Revit and this price list, it's only the products and their finishes as described in this price list that are available. It is possible that a finish, dimension or entire product featured in pCon/Revit can not be purchased anymore.

WEBSITE

In case of a price anomaly between our website and this price list, it's the price in this price list that is valid and that will be charged.

In case of a finish anomaly between our website and this price list, it's only the products and their finishes as described in this price list that are available. It is possible that a finish, dimension or entire product featured on our website can not be purchased anymore.



+ 32 15 28 28 28

info@bulo.be

www.bulo.com

HEADQUARTERS

Blarenberglaan 6

2800 Mechelen

Belgium

BULO USA, LLC

15 W. 38th Street- Suite 609

New York, NY 10018

USA